

Owner's Safety Manual



Sailing Yacht "Hanse 575"

HanseYachts AG
Salinenstraße 22
17489 Greifswald /Germany
Tel.: +49 (0) 3834 5792-0; Fax: +49 (0)3834 5792-81
www.hanseyachts.com

Details:
Owner's Safety Manual
Owners Manual 575 Buch eng V4.1.docx
July 2013

Table of Contents

Introduction	III
Design Category, Identification	V
Builder's Plate	V
Warning Notes	VI
Declaration of Conformity	VII
CHAPTER 1 – SAFETY NOTES	1
1. Description of the Boat	1
1.1. GENERAL DESCRIPTION	1
1.2. MAIN DATA	1
1.2.1. Main dimensions	1
1.2.2. Displacement and masses	3
1.2.3. Maximum number of persons and load capacity	3
1.2.4. Motorization	4
1.2.5. Electrical system	5
1.3. GENERAL PLAN	6
1.3.1. Description of the structure	6
1.3.2. Sail plan	10
1.3.3. Rigging plan and halyard running	11
1.3.4. General arrangement	16
1.4. PROPULSION SYSTEM	17
1.4.1. Engine, Engine room, reduction gear	17
1.5. SAFETY NOTES	17
1.5.1. Flooding, watertight integrity	17
1.5.2. Hull openings, seacocks	18
1.5.3. Stability	23
1.5.4. Fire protection	23
1.5.5. In-Mast furling mainsail	28
CHAPTER 2 – FURTHER TECHNICAL DETAILS	29
1. Installations and Systems	29
1.1. TANK CAPACITIES	29
1.2. WATER SYSTEMS	30
1.2.1. Drinking water	33
1.2.2. Seawater	33
1.2.3. Black water	34
1.2.4. Bilge system	35
1.3. FUEL SYSTEM	37
1.4. STEERING SYSTEM	40
1.5. ELECTRICAL SYSTEMS	42
1.5.1. Direct current system	46
1.5.2. Alternating current system	48
1.5.3. Navigation systems	50
1.6. ANCHORING, TOWING AND MOORING EQUIPMENT	50
1.6.1. General	50
1.6.2. Anchoring	50
1.6.3. Towing	51
1.6.4. Mooring	51
1.7. ENGINE SYSTEM	51
1.7.1. Structure of the engine room	51
1.7.2. General	52
1.7.3. Instruments	52
1.7.4. Cooling system	53
1.7.5. Exhaust system	55
1.7.6. Lubrication	55
1.7.7. Gearing	55
1.7.8. Gear shift	55
1.7.9. Shafting	56

1.7.10. Propeller	57
1.8. VENTILATION	57
1.9. HEATING	57
1.10. AIR CONDITION	60
1.11. GENERATOR	63
1.12. BOW THRUSTER / STERN THRUSTER	64
1.13. LIQUEFIED PETROLEUM GAS SYSTEM	64
1.13.1. Installation	64
1.13.2. Replacement of the gas cylinder	65
1.13.3. Operating the gas system	66
1.14. CORROSION PROTECTION, PAINTING SYSTEM	67
1.15. MANUALS AND OPERATING INSTRUCTIONS	67
2. Starting up	68
2.1. GENERAL NOTES	68
2.2. ATTACHMENT POINTS FOR LIFTING GEAR, SUPPORT POINTS FOR SLIPPING AND TRANSPORT	68
2.3. UNDERWATER PAINTING	69
2.4. ENGINE, PROPELLER	69
2.5. EQUIPMENT	69
2.6. FIRST VOYAGE	69
2.7. MANOEUVRING BY ENGINE	69
2.8. CHECKING THE SYSTEMS	70
3. Environmental Protection	70
3.1. FUELS AND OIL	70
3.2. WASTE	70
3.3. SOUND	70
3.4. SWELL	70
3.5. EXHAUST GASES	71
3.6. ANTIFOULING, PAINTING	71
3.7. VARNISH REMOVER	71
3.8. BLACK WATER	71
3.9. NATURE CONSERVATION	71
4. Maintenance	72
4.1. EXTERNAL INSPECTION	73
4.2. MAINTENANCE AND CLEANING	73
4.3. RIGGING AND SAILS	74
4.3.1. Rigging	74
4.3.2. Sails	75
4.4. PAINTING	75
4.5. WEAR AND SPARE PARTS	75
4.6. REPAIRS	75
4.7. INSPECTION OF UNITS AND SYSTEMS	75
4.8. WINTER STORAGE	77
4.8.1. Hull and deck	77
4.8.2. Rigging	77
4.8.3. Electrical equipment	77
4.8.4. Systems and tanks	77
5. Live saving appliances	78
6. Warranty	78
7. Concluding remarks and notes	78
8. List of delivered manuals, plans and operating instructions	79

Proof of Identity

Acknowledgement of Receipt

Introduction

This manual is to help you handle your sailing yacht safely and with pleasure. It contains general information on the yacht and its systems, as well as on operation and maintenance. Please use this manual to acquaint yourself with your yacht before setting off on your first voyage. Further help regarding individual devices that are part of the yacht's equipment can be obtained in the device's operating instructions.

This Skipper's Manual is not a course dealing with watercraft safety or the art of sailing. For your own safety and convenience, should this be your first sailing yacht or if you are not yet familiar with the special features of a sailing yacht, please acquaint yourself with the handling and operation of this yacht before taking charge of it. Your dealer or national sailing or motor boat association or yacht club will be pleased to inform you of training possibilities in case you would like to expand or refresh your knowledge in this way.

Please make sure that the expected wind and swell conditions are in accordance with the design category of your boat and that you and your crew are capable of handling the boat under these conditions.

Your yacht is adequately designed, but you must be able to cope with the sea and wind conditions of storms of category A up to the serious conditions of the top category C, including the risk of breakers or strong gusts of wind, which comply with the design categories A, B and C. They are considered to be dangerous conditions under which only a competent, capable and trained crew with a well maintained watercraft can operate in a satisfactory manner.

This manual is not a detailed instruction guide for maintenance or trouble-shooting. In case of problems, please consult your dealer. If a maintenance manual is provided, use it to perform maintenance on your watercraft.

Only commission trained and competent staff for maintenance, repairs or modifications of this yacht. Modifications that could have an impact on the safety features of the boat must be assessed, implemented and recorded by qualified specialists. The boat's manufacturer cannot be made responsible for modifications that he has not approved.

In some countries, a license or an authorisation is required, or special regulations apply.

Perform maintenance work on your boat in a proper manner and consider the wear that can occur over time and through frequent or improper use of the boat.

Any watercraft, no matter how solidly it is built, can be seriously damaged by improper handling. This is not compatible with safely handling of your boat. Always adapt the boat's speed and direction of travel to the sea conditions.

If your boat is equipped with an inflatable life raft, read the corresponding operating instructions carefully. The watercraft should have the appropriate rescue equipment on board (life jackets, safety belts, etc.) in accordance with the type of watercraft, the weather conditions, etc. In some countries, this equipment is mandatory. The crew should be familiar with how to handle all safety equipment and with manoeuvring in cases of emergency (man-overboard rescue, mooring, etc.). Sailing and motor boat schools and clubs organise training courses on a regular basis.

When above deck, all persons should wear buoyancy aids (life jackets, personal buoyancy aids). Please pay attention to the fact that in some countries legal requirements stipulate wearing a buoyancy aid in compliance with national regulations.

We recommend keeping this manual on board so that it can be used as an operating guide or for possible trouble-shooting.

Certain figures may contain equipment features that are not included in the contract.

**PLEASE KEEP THIS MANUAL IN A SAFE PLACE AND GIVE IT TO
THE NEW OWNER IF YOU SELL THE YACHT.**

The **HanseYachts AG** warmly welcomes you to the circle of Hanse sailing yacht owners and thanks you for the confidence you have placed in our product by purchasing this yacht.

Your contracting party as well as the management and employees of **HanseYachts AG** wish you a lot of pleasure with your new sailing yacht.

May you always have good sailing!

HanseYachts AG

Management

Design Category

According to the European Recreational Craft Directive each craft has to meet the requirements of the intended design category.

The sailing yacht “Hanse 575” is certified according to design category A.

In the Directive, design category A is characterised as follows:

Design category A: Ocean

Designed for extended voyages where conditions may exceed wind force 8 (Beaufort scale) and significant wave heights of 4 m and above but excluding abnormal conditions, and vessels largely self-sufficient.

Certification

In accordance with the EC Directive, the certification module B+C was chosen for this yacht. The notified body issued an EC type-examination certificate for this type, certifying that the essential requirements were checked and have been fulfilled. The manufacturer confirms the conformity with the type.

The **Germanischer Lloyd AG**, located in Hamburg, was commissioned as a notified body according to the EC Recreational Craft Directive (see Declaration of Conformity).

Identification

The hull identification is mounted on the starboard side of the transom. It is a globally unique sequence of numbers and letters.

This number is affixed a second time at a hidden place only known to the manufacturer in order to identify your yacht in case of theft.

The number is:

DE-HANT0042G314

Builder's Plate

In accordance with the requirement of the Directive, the builder's plate is affixed in the cockpit. The information it contains is stipulated and should be explained here.

	
Auslegungskategorie A	
Max.	 12 = 900 kg
Max.	 +  = 2381 kg
Hersteller: HanseYachts AG Germany Salinenstr. 22 17489 Greifswald	
Notified Body: GL	

Explanations

- Design Category A :

- Max.  12 = 900 kg:

- Max.  = 2.381 kg:

- CE:

Ocean

Maximum number of persons defined by the manufacturer when the boat is underway in the sea territory of its design category.

The maximum additional load consisting of 12 persons, basic equipment, life rafts, provisions stores and cargo (tank capacities are not included). Please take note of section 1.2.2.

CE marking as proof that the boat was built according to the requirements of the Directive

Warning Notes

In many chapters of the owner's manual you will find notes meant to facilitate trouble-free operation and maintenance, but also to warn against dangers. For reasons of clarity, they are highlighted in boxes.



Denotes that an extreme intrinsic hazard exists which would result in high probability of death or irreparable injury if proper precautions are not taken.



Denotes that a hazard exists which can result in injury or death if proper precautions are not taken.



Denotes a reminder of safety practices or directs attention to unsafe practices which could result in personal injury or damage to the craft or components.



Here we give you valuable advice facilitating the operation or handling of the craft or its components.

DECLARATION OF CONFORMITY
of Recreational Craft with the Design, Construction and Noise Emission requirements of
Directive 94/25/EC as amended by Directive 2003/44/EC

(To be completed by boat builder)

Name of craft manufacturer: HanseYachts AG
Address: Salinenstraße 22
Town: Greifswald **Post Code:** 17489 **Country:** Germany

Name of Notified Body for design and construction assessment (if applicable)

Name: Germanischer Lloyd AG
Address: Postbox 11 16 06
Town: Hamburg **Post Code:** 20416 **Country:** Germany **ID-Number:** 0098
EC type-examination Certificate number: 92134 **Date: (year/month/day)** 2012/08/13
When assessment accord. ESR3.2 and 3.3: ----- Date: (year/month/day) ----/--/--

Name of Notified Body for noise emission assessment (if applicable)

Name:
Address:
Town: **Post Code:** **Country:** **ID-Number:**

Module used for construction assessment: A Aa B+C B+D B+E B+F G H

Module used for noise emission assessment: A Aa G H

Other Community Directives applied:

DESCRIPTION OF CRAFT

Craft Identification Number (CIN):

D E - H A N T 0 0 4 2 G 3 1 4

Brand name of the craft: Hanse 575

Type or Number: Deep keel

Type of craft

sailboat motorboat
 inflatable
 other (specify):

Type of main Propulsion

Sails petrol engine
 diesel engine electric motor
 oars
 other (specify):

Type of hull

monohull multihull
 other (specify):

Type of engine

outboard inboard
 z or sterndrive without integral exhaust
 z or sterndrive with integral exhaust
 other (specify):

Construction material:

aluminium, -alloys plastic, FRP
 steel, -alloys wood
 other (specify):

Deck

fully decked partly decked
 open
 other (specify):

Maximum Design Category: A B C D

Engine power **Max. Recommended:** 110 kW
Installed 110 kW (if applicable)

Length of hull L_h: 16.70 m **Beam of hull B_h:** 5.20 m **Draught T:** 2.85 m

This declaration of conformity is issued under the sole responsibility of the manufacturer. I declare on behalf of the craft manufacturer that the craft mentioned above complies with all applicable essential requirements in the way specified, and is in conformity with the type for which above mentioned EC type examination certificate has been issued.

Name and function: Gregor Bredenbeck
(identification of the person empowered to sign on behalf of the
manufacturer or his authorised representative)

Signature and title:
(or an equivalent marking)

Date and place of issue: **(year/month/day)** Greifswald, 2012/12/03

Essential requirements (reference to relevant articles in Annex IA & IC of the Directive)	ISO-standards	Other normative document/ methods	Technical file	Please specify in more detail (*: Mandatory Standards)
General requirements (2)	<input checked="" type="checkbox"/>			EN ISO 8666:2002*
Craft Identification Number – CIN (2.1)	<input checked="" type="checkbox"/>			EN ISO 10087:2006*
Builder's Plate (2.2)	<input checked="" type="checkbox"/>	<input type="checkbox"/>	<input checked="" type="checkbox"/>	EN ISO 14945:2004*
Protection from falling overboard; means of re-boarding (2.3)	<input checked="" type="checkbox"/>	<input type="checkbox"/>	<input checked="" type="checkbox"/>	EN ISO 15085:2009*
Visibility from the main steering position (2.4)	<input type="checkbox"/>	<input type="checkbox"/>	<input type="checkbox"/>	
Owner's manual (2.5)	<input checked="" type="checkbox"/>	<input type="checkbox"/>	<input checked="" type="checkbox"/>	EN ISO 10240:2004*
Integrity and structural requirements (3)				
Structure (3.1)	<input checked="" type="checkbox"/>	<input checked="" type="checkbox"/>	<input checked="" type="checkbox"/>	EN ISO 12215-1:2000; -2:2002; -4:2002; -5:2008; -6:2008; -8:2009; -9:2012
Stability and freeboard (3.2)	<input checked="" type="checkbox"/>	<input type="checkbox"/>	<input checked="" type="checkbox"/>	EN ISO 12217-2:2002*
Buoyancy and floatation (3.3)	<input checked="" type="checkbox"/>	<input type="checkbox"/>	<input checked="" type="checkbox"/>	EN ISO 12217-2:2002*
Openings in hull, deck and superstructure (3.4)	<input checked="" type="checkbox"/>	<input type="checkbox"/>	<input checked="" type="checkbox"/>	EN ISO 12216:2002*; 9093-1:1997*; 9093-2:2002*
Flooding (3.5)	<input checked="" type="checkbox"/>	<input type="checkbox"/>	<input checked="" type="checkbox"/>	EN ISO 11812:2001*; 9093-1:1997*; 9093-2:2002*; 15083:2003*
Manufacturer's maximum recommended load (3.6)	<input checked="" type="checkbox"/>	<input type="checkbox"/>	<input checked="" type="checkbox"/>	EN ISO 14946:2001*
Liferaft stowage (3.7)	<input type="checkbox"/>	<input type="checkbox"/>	<input checked="" type="checkbox"/>	
Escape (3.8)	<input checked="" type="checkbox"/>	<input type="checkbox"/>	<input type="checkbox"/>	EN ISO 9094-1:2003*
Anchoring, mooring and towing (3.9)	<input checked="" type="checkbox"/>	<input type="checkbox"/>	<input checked="" type="checkbox"/>	EN ISO 15084:2003*
Handling characteristics (4)	<input type="checkbox"/>	<input type="checkbox"/>	<input type="checkbox"/>	
Engines and engine spaces (5.1)				
Inboard engine (5.1.1)	<input checked="" type="checkbox"/>	<input type="checkbox"/>	<input checked="" type="checkbox"/>	EN ISO 16147:2002*
Ventilation (5.1.2)	<input type="checkbox"/>	<input type="checkbox"/>	<input checked="" type="checkbox"/>	
Exposed parts (5.1.3)	<input type="checkbox"/>	<input type="checkbox"/>	<input checked="" type="checkbox"/>	
Outboard engine starting (5.1.4)	<input type="checkbox"/>	<input type="checkbox"/>	<input type="checkbox"/>	
Fuel system (5.2)				
General – fuel system (5.2.1)	<input checked="" type="checkbox"/>	<input type="checkbox"/>	<input checked="" type="checkbox"/>	EN ISO 10088:2009*; EN ISO 7840:2004*
Fuel tanks (5.2.2)	<input checked="" type="checkbox"/>	<input type="checkbox"/>	<input checked="" type="checkbox"/>	EN ISO 10088:2001*
Electrical systems (5.3)	<input checked="" type="checkbox"/>	<input type="checkbox"/>	<input checked="" type="checkbox"/>	EN ISO 10133:2012* ;13297:2012*
Steering systems (5.4)	<input type="checkbox"/>	<input type="checkbox"/>	<input checked="" type="checkbox"/>	
General – steering system (5.4.1)	<input checked="" type="checkbox"/>	<input type="checkbox"/>	<input checked="" type="checkbox"/>	EN ISO 8847:2004*
Emergency arrangements (5.4.2)	<input checked="" type="checkbox"/>	<input type="checkbox"/>	<input checked="" type="checkbox"/>	EN ISO 8847:2004*
Gas systems (5.5)	<input checked="" type="checkbox"/>	<input checked="" type="checkbox"/>	<input checked="" type="checkbox"/>	EN ISO 10239:2008* ; DVGW G608 (Germany)
Fire protection (5.6)				
General – fire protection (5.6.1)	<input checked="" type="checkbox"/>	<input type="checkbox"/>	<input checked="" type="checkbox"/>	ISO 9094-2:2002*
Fire-fighting equipment (5.6.2)	<input checked="" type="checkbox"/>	<input type="checkbox"/>	<input checked="" type="checkbox"/>	ISO 9094-2:2002*
Navigation lights (5.7)	<input type="checkbox"/>	<input checked="" type="checkbox"/>	<input checked="" type="checkbox"/>	COLREG
Discharge prevention (5.8)	<input checked="" type="checkbox"/>	<input type="checkbox"/>	<input checked="" type="checkbox"/>	EN ISO 8099:2000*
Annex I.B – Exhaust Emissions	see the Declaration of Conformity of the engine manufacturer			
Annex I.C – Noise Emissions ¹	<input type="checkbox"/>	<input type="checkbox"/>	<input checked="" type="checkbox"/>	2003/44/EC
Noise emission levels (I.C.1)	<input type="checkbox"/>	<input type="checkbox"/>	<input checked="" type="checkbox"/>	2003/44/EC
Owner's manual (I.C.2)	<input type="checkbox"/>	<input type="checkbox"/>	<input checked="" type="checkbox"/>	2003/44/EC

¹ Only to be completed for boats with inboard engines or sterndrive engines without integral exhaust



Chapter 1 – Safety Notes

1. Description of the Boat

1.1. General description

You can find the general description of the yacht in the standard specification and the corresponding contract specification.

1.2. Main data¹

1.2.1. Main dimensions

Maximum length	L_{\max}	17.33 m
Length of hull	L_H	16.70 m
Length of waterline	L_{WL}	15.15 m
Beam of hull	B_H	5.20 m
Mast height		25.30 m
Draught (lower edge of the keel)	T_{\max}	
Deep keel		approx. 2.85 m
Shallow keel (option) ²		approx. 2.25 m
Sail surface ²		
Fully-battened Mainsail		87.50 m ²
In-Mast furling Mainsail		79.00 m ²
Self-tacking jib		63.00 m ²
Genoa 105%		74 m ²



The specified sail surface may not be expanded without prior consultation with the shipyard.

¹ All dimensions, weights and surfaces are approximate values.

² Depending on the contract specification.

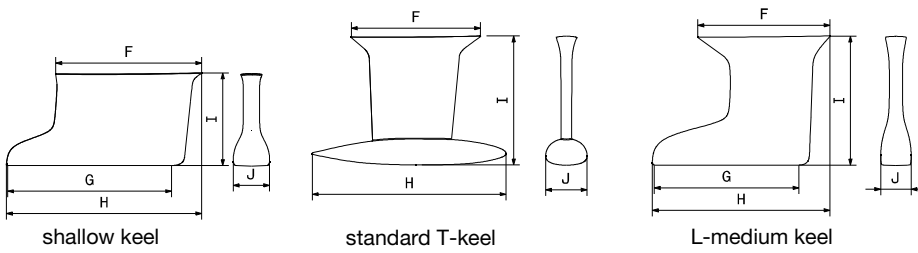
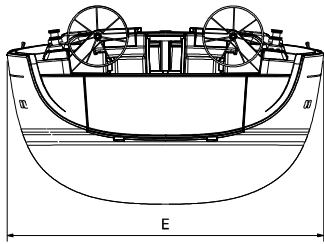
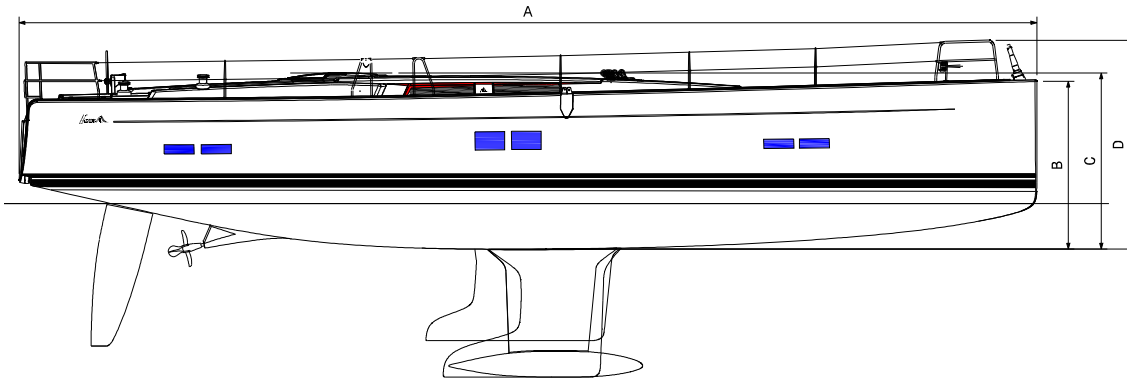

- A = length of hull: 16.69 m
- B = height of hull: 2.75 m
- C = height hull – deck: 2.90 m
- D = height hull – pulpit: 3.43 m
- E = beam of hull: 5.20 m

Keel dimension:

	shallow keel	standard T-keel	L-medium keel
F	2.40m	2.13 m	2.17 m
G	2.69 m		2.37 m
H	3.21 m	3.18 m	2.92 m
I	1.52 m	2.12 m	2.12 m
J	0.60 m	0.68 m	0.50 m

Fuel tank content	540 l
Water tank content	770 l
Maximum number of persons	12 Crew

1.2.2. Displacement and masses

		Shallow keel	Medium keel
Mass of the empty vessel	m_{LCC}	19.973 kg	19.173 kg
Optional equipment		1.804 kg	1.804 kg
Mass of liquids in installed tanks		1.225 kg	1.225 kg
Basic equipment ^{*)}		551 kg	551 kg
Life raft ^{*)}		80 kg	80 kg
Stores and cargo ^{*)}		550 kg	550 kg
Provisions ^{*)}		300 kg	300 kg
Number of persons (12 persons) ^{*)}		900 kg	900 kg
Mass of the fully loaded boat – ready to sail	m_{LDC}	25.383 kg	24.583 kg

*) Included in the load capacity on the builder's plate



The owner or skipper is responsible for ensuring that the fully equipped boat does not exceed the mass according to the table above.

1.2.3. Maximum number of persons and load capacity

The directive requires that for each craft a maximum number of persons is defined who should be on board when the boat is in the service area it was conceived for. This yacht is designed for the ocean navigation, i.e. for extended voyages between ports.

Therefore the recommendation is the following:

Voyages of several days duration the maximum number of persons should be greater than the number of berths onboard.

This design category considers a maximum wave height of more than 4 m and a wind speed of more than 8 Beaufort, under the precondition that:

- the crew has sufficient nautical knowledge and experience;
- the construction of the boat is suitable for the intended weather conditions and its equipment is well maintained.



Life jackets must be provided for all persons on board. The inflatable life raft should have a capacity of 12 persons.



Put on personal safety equipment (life jacket etc.) during the trip!



The defined maximum number of persons may not be exceeded. No matter how many persons are on board, the total weight of persons and equipment may never exceed the recommended maximum load capacity.



The stability characteristics of the craft were designed for the specified weights and the intended arrangement and storage of the additional load.

The following notes should be paid attention:

- the crew members should be trained sufficiently;
- the boat should not be loaded beyond the limit recommended by the manufacturer;
- water in the bilge should be drained to the greatest extent possible;
- stability is reduced by heavy loads above the centre of gravity;
- in case of rough weather, the hatches, locker seats and companionways must be kept shut to keep the risk of water penetration as low as possible;
- stability is reduced, if davits are used for towing or for lifting heavy weights;
- breaking waves are dangerous and may influence the stability of the yacht.



Weather conditions under which breaking waves could approach the boat abeam are to be avoided. Voyages should be planned in consideration of weather forecasts.

Additional load

The Directive requires the specification of the maximum additional load by the manufacturer. It contains persons and the equipment marked with ⁷ in 1.2.2. The maximum load capacity is indicated on the builder's plate. The maximum additional load for the "Hanse 575" is 2.381 kg.



The specified maximum additional load must never be exceeded when loading the craft. Loading must always be carried out cautiously, distributing the load in such a way that the design trim is maintained. Heavy load must be placed as low as possible.

Liquids are not considered in the maximum additional load.



When the space underneath the floor or the beds is used as store room, it has to be ensured that here installed devices and appliances will not be damaged.

1.2.4. Motorization

For engine details and its technical specifications, please refer to the operating instructions for the engine and the contract specification.

Max. power (EN ISO 8665)	max. 110 kW (163 HP)
Number	1
Cooling	indirect (seawater/fresh water)

1.2.5. Electrical system

The yacht is equipped with an electrical system with 12 V direct current and a 230 V alternating current system.

Do not modify the craft's electrical systems or relevant drawings. Installation, alterations and maintenance should be performed by a competent marine electrical technician. Inspect the system at least biennially.



Open the switchboards only when they are current free, because you might contact live elements that are not protected by fuses. There is a risk of electric shock.



There is a risk of fire and explosion when handling electrical direct current (DC) and alternating current (AC) systems in an improper manner.

230 V ALTERNATING CURRENT



Never perform work on a live alternating current system.

Heed the following notes:

- If possible, only use electrical consumers with earthed conductors.
- Connect metal housings or systems of installed electrical devices to the earthed conductor in the boat (green or green with yellow stripes).



Never leave the shore-connecting cable hanging in the water. This could injure or result in the death of persons swimming nearby!



To avoid electric shocks and to reduce the risk of fire

- Do not modify the electrical system. Allow work to be done on the electrical system only by qualified specialists for marine electrical equipment!
- If possible, only use devices that are insulated twice or triple braided!
- Switch the shore connection switch off first before plugging or unplugging the shore connecting cable.
- Connect the shore-connecting cable to the boat first before connecting it to the shore source of power.
- First separate the connection at the shore source of power.
- If the reverse polarity display¹ is activated, disconnect immediately!
- Close the cap of the shore connector box.
- Do not modify the shore connections, only use compatible circuit connectors.

¹ Depending on the contract specification

12 V direct current

Batteries supply the current for the 12V installation on board.

Distribution occurs via the distribution fuse panel. The labels next to the switches designate the respective consumers. If required, your dealer can provide the circuit diagram.

Changing the batteries

When removing the batteries, always disconnect the negative pole first and make sure that the pole terminal does not come in contact with other parts of the electrical system! Take care not to simultaneously touch both poles with the tool you are using, thus establishing an electric circuit.



Only use insulated tools to detach or fasten the pole terminals at the batteries.

There is a risk of fire and injuries!

When connecting the batteries, take care to first plug in and secure the positive poles before subsequently attaching the negative poles.

Electrical winches

Don't underrate power of electric winches and use them with carefulness. In cases of misapplication the craft may be get damaged like in the following examples: downhaul fittings break away or push in the mast; clews of sails, deck fittings or roller reefing system get damaged or break away.



DO NOT use e-winch for human suspension!

1.3. General plan**1.3.1. Description of the structure****Structure**

The sailing yacht "Hanse 575" is a cruiser constructed using a combination of vinyllester sandwich (hull) and FRP sandwich (deck).¹

The properties of all utilised materials comply with the requirements of classification societies or ISO standards.

Should you require these materials or the accompanying data sheets, please contact your dealer.

Always maintain a sufficient distance to the sea bed. On principle, it is not possible to take severe collisions with solid underwater obstacles into account when dimensioning the yacht.



Touching the sea bed or collisions with objects below the waterline can result in damage to the hull and thus impair its strength.

Preservation

Osmosis protection is ensured by the use of an isophthalic acid gel coat and an vinyllester resin for the hull outer skin. In addition, areas of the laminate surfaces heavily exposed to water were preserved with a top coat.

All parts not consisting of FRP are necessarily colour-preserved or consist of materials which are corrosion resistant.

The underwater part was preserved with a special antifouling painting system to prevent marine fouling.

Deck covering

All areas of the working deck are covered with anti-slip surfaces.

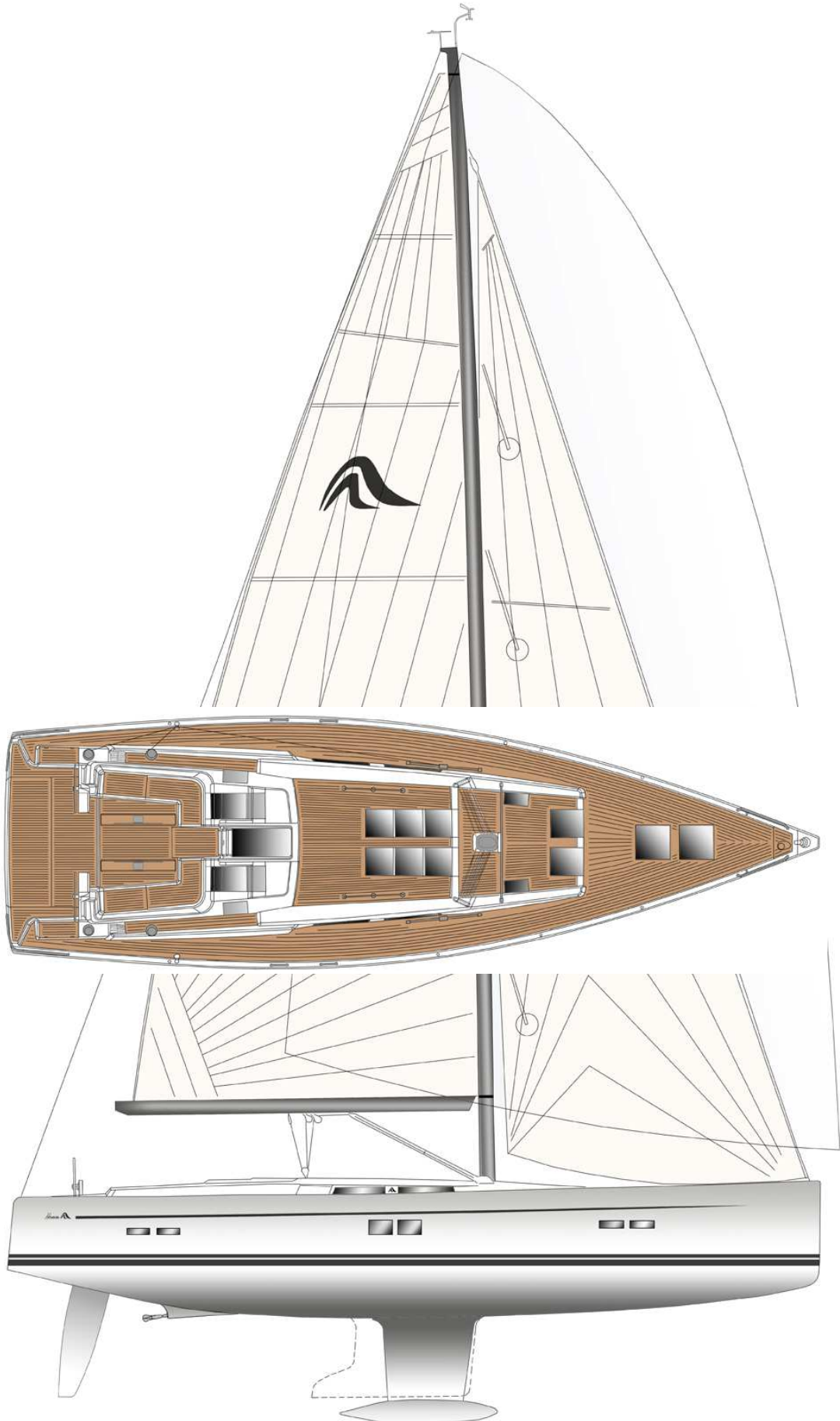

Fig. 1 General plan

Fittings and hatches

All hinges and hatches are made of stainless- and sea-water resistant material. They are carefully screwed on deck in order to be watertight. At the mounting points of the fittings reinforcements are laminated into the deck so that existing forces can be transferred into these points.

The hatches and portlights as well as the windows are certified or in compliance with the requirements or regulations such that they resist the impact of breaking waves.

Working deck

The working deck consists of all areas that must be accessed to operate the boat under normal conditions. The bathing platform and the transom do not belong to the working deck (Fig 3).



Warning

Never enter the areas that do not belong to the working deck when the boat is underway. There is a risk of falling overboard.

Only step or stand on the seats in the cockpit to move about on deck! Don't step on the sliding hatch at the companionway or its cover!

It is generally recommended to secure persons on deck with personal rescue and safety equipment (e.g. life jackets, safety belts).



Danger

Please make sure that you do not enter between the bulwark and the quay wall or other boats.

There is no foot stop at the rear part of the cockpit. Please take note of this when you are there.



Attention

Do not leave loose objects lying in the area of the working deck or the emergency hatches. Secure all pieces of equipment against sliding!

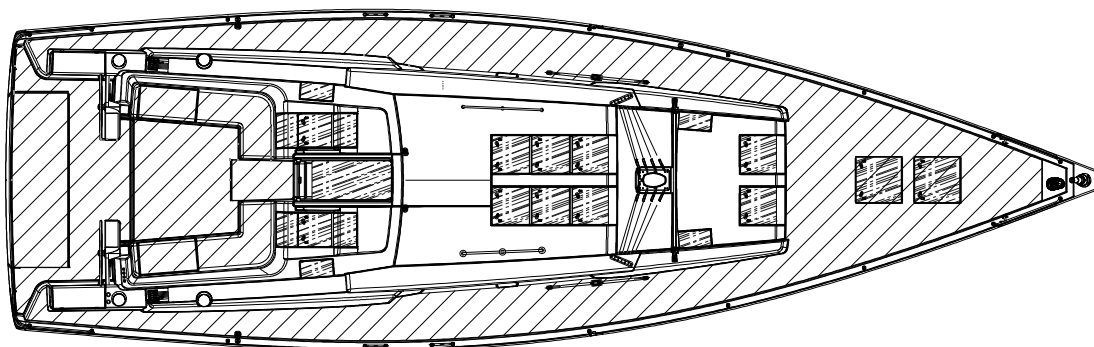

Guardrail

The boat has a surrounding guardrail with a hand and intermediate rail. Except for the bow and stern pulpits, the hand and intermediate rails are made of stainless steel.

Handrails and boarding ladder

Additional handrails and the arrangement of the deck fittings provide protection against falling overboard.

The rescue ladder is at the transom. It extends below the waterline. Re-boarding is ensured by the rescue ladder. Familiarize yourself with the handling of the rescue ladder and practice re-boarding, e.g. in a man overboard manoeuvre (MOB).

An additional boarding ladder is fixed mounted on the bathing platform. In an emergency to rescue open the bathing platform and fold down the boarding ladder in the water.



Instruct the crew before you start the voyage! We advise you against sailing the yacht alone (single-handed yachtsman).

The specific means of reboarding are not deployable by a person in the water!

The means of reboarding shall be permanently deployed if the craft is used singlehanded, whether anchored, moored, stationary or under way.

One should furthermore take precautions to comply with the "rules of good seamanship" (lifebelt, life lines, connecting belt as short as possible ...).

1.3.2. Sail plan

Fully-battened Mainsail	87.5 m ²
Self-tacking jib	63.0 m ²
Genoa (105%)	74.0 m ²

P	=	21.00 m
E	=	7.10 m
IG	=	21.70 m
J	=	6.39 m
LP (ST Jib)	=	5.70 m
LP (106%)	=	6.70 m

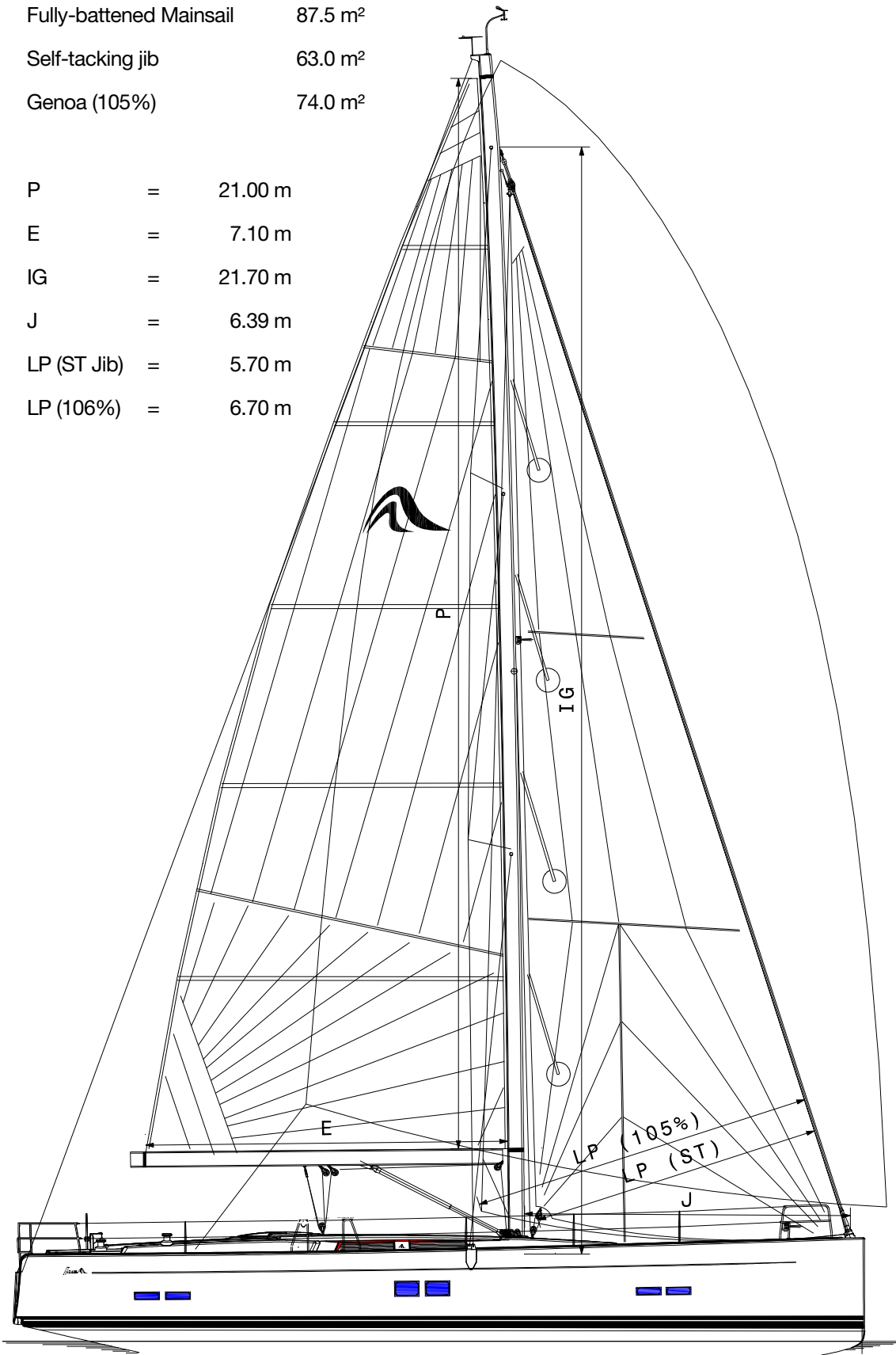

1.3.3. Rigging plan and halyard running

The Selden mast is put through deck.

- Mast length: 25.52 m
- Mast profile: C304
- Boom length: 7.47 m
- Boom profile: B300

General rig description

Conventional	Fractional
Keelstepped	3-spreader
Tapered	Sloop

Rig dimensions

Forestay height	FH:	21 430 mm
Main sail luff length	P:	21 000 mm
Boom height above deck	BH:	1 620 mm
Bury	Q:	2 650 mm
Main sail foot length	E:	7 100 mm
Main boom sheet pos	S:	3 600 mm
Foretriangle width	J:	6 400 mm
Spinnaker pole length	SPL:	6 400 mm

Chainplates dist. from cl mast

	Lateral	Long
Cap shrouds:	2365	955 mm (22,0°)
Aft lowers:	2365	885 mm
Deck above chainplates:	139 mm	
Deck above waterline:	1976 mm	

Hull and righting moment

Length:	16 690 mm
Beam:	5 200 mm
Draft:	2 850 mm
Displacement:	19 500 Kg
Ballast:	5 700 Kg
Bulb/wing keel, Equipped boat	
Heeling test RM:	136,3 kNm @30°

Spar sections

Mast:	C304
Boom:	B300
Spin. pole:	S140

Max spin/gennaker height: 22580 (1150mm above FH)
 Max code zero height: 22230 (800mm above FH)
 2:1 purchase system for code zero halyard

Furlex

Forestay: 412

Notes (8 lines)

iPreliminary rig setup, suggested, by Seldén. Data to be confirmed.

Mast section is optimized for RM30=136kNm. Higher RM may result in change of section / setup.

Check stays optional, but recommended in rough conditions, over seas journeys and motoring in big waves.

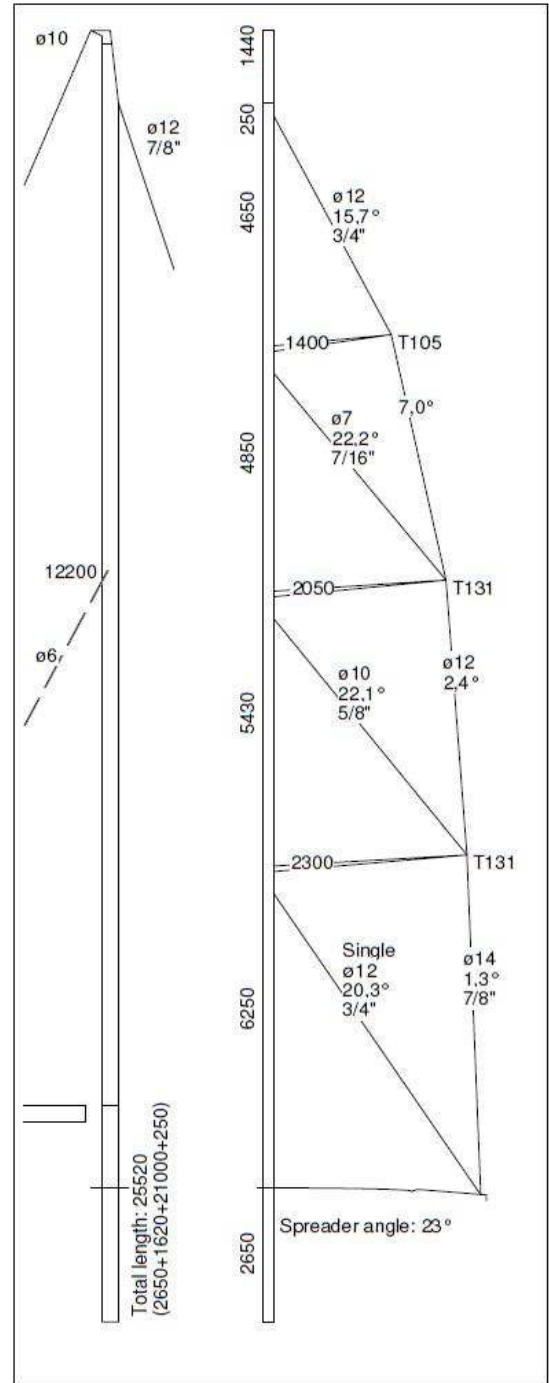

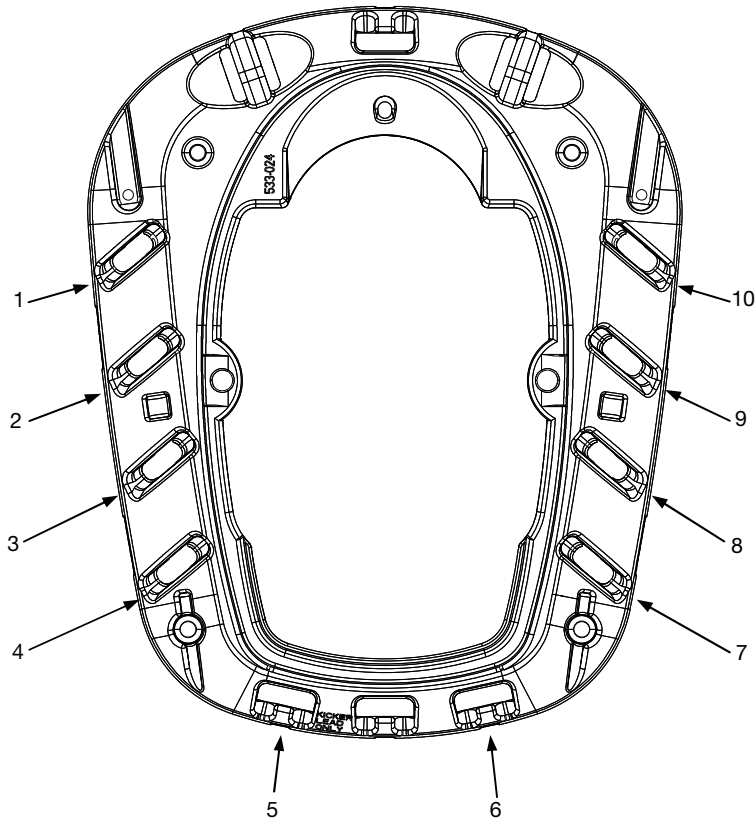

Halyard running

- | | |
|------------------------------|--------------------|
| 1. JIB halyard | 6. Outhaul |
| 2. Genoa / Spinnaker halyard | 7. Main sheet stbd |
| 3. Reef 2 | 8. Reef 1 |
| 4. Main sheet prt | 9. Main halyard |
| 5. Boom vang | 10. JIB sheet |

Overview running rigging

name	material	diameter	length	identifying thread
Main halyard	Liros Regatta 2000	12 mm	57 m	blue /blue
JIB halyard	Liros Regatta 2000	12 mm	52 m	blue / red
Boom lift	Liros Top Cruising	10 mm	50 m	white
Outhaul	Liros Top Cruising	14 mm	22 m	white / red
Reef 1	Liros Top Cruising	14 mm	34 m	white / yellow
Reef 2	Liros Top Cruising	14 mm	48 m	white/ green
Main sheet	Liros Top Cruising	14mm	55 m	white
JIB sheet	Liros Top Cruising	14 mm	40 m	white / black
Boom vang	Liros Top Cruising	12 mm	21 m	black

Option Gennaker

Gennaker halyard	Liros Regatta 2000	12 mm	65 m	blue /yellow
Gennaker sheets	Liros Herkules	12 mm	28 m	red

Forestay with Furlex system

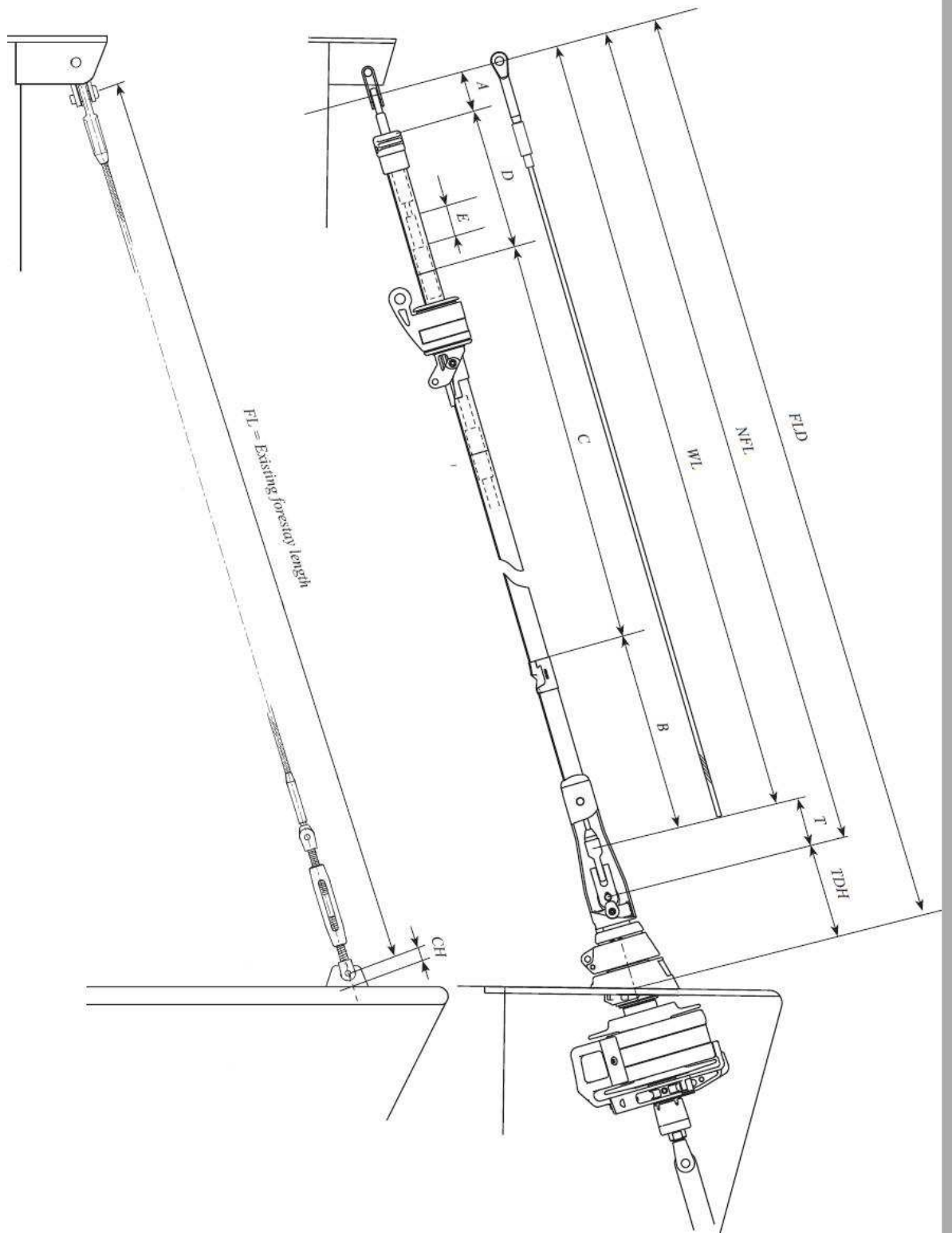

Calculating the length of the forestay wire

A copy of Hanse 575 table from the Furlex 400TD manual.

1. Determine the rake of the mast with the fore-/backstay tensioned.
2. Slacken the backstay as much as possible, but make sure that any rigging screw is not unscrewed so far that the threads are no longer visible "on the inside". The forestay setting should not be adjusted. If the forestay rigging screw must be adjusted, first mark its thread with adhesive tape.
3. Pull the masthead forward using the genoa halyard. Secure the halyard using a "D" shackle or tie it to a strong deck fitting. For safety reasons, do not use the halyard snap shackle.



Always use a strong "D" shackle or tie the halyard!

4. Take down the forestay. If the rigging screw was adjusted, return it to its original setting.
5. Measure the forestay length (FL) with just enough tension to keep it straight.
6. Enter the measurement in Table 1 below, under the heading "Your forestay", in the row marked FL.
7. Calculate the new wire length WL in Table 1. Refer to the column marked "example" and fig. 3.7.a to see how this is done.

	Table 1: Calculation of forestay wire length	Your forestay						
FL	Existing forestay length FL including rigging screw, no tension. (See fig. 3.5.a)							
CH	Add the distance between the hole in the chain plate and deck level. The measurement to be taken along the forestay line. (See fig. 3.5.c)	+						
FLD	FL + CH = FLD. = FL also corresponds to any measurement taken from the rig drawing of the boat.							
TDH	Deduction for the level of Furlex TD above deck <table border="1" style="margin-left: 20px;"> <thead> <tr> <th colspan="2">TD-deduction</th> </tr> </thead> <tbody> <tr> <td>Ø 12 mm wire:</td> <td>250 mm (9 27/32")</td> </tr> <tr> <td>Ø 14 mm wire:</td> <td>250 mm (9 27/32")</td> </tr> </tbody> </table>	TD-deduction		Ø 12 mm wire:	250 mm (9 27/32")	Ø 14 mm wire:	250 mm (9 27/32")	-
TD-deduction								
Ø 12 mm wire:	250 mm (9 27/32")							
Ø 14 mm wire:	250 mm (9 27/32")							
NFL	New forestay length =							
T	Deduction for wire terminal + toggle <table border="1" style="margin-left: 20px;"> <thead> <tr> <th colspan="2">TD-deduction</th> </tr> </thead> <tbody> <tr> <td>Ø 12 mm wire:</td> <td>110 mm (4 1/3")</td> </tr> <tr> <td>Ø 14 mm wire:</td> <td>135 mm (5 5/16")</td> </tr> </tbody> </table>	TD-deduction		Ø 12 mm wire:	110 mm (4 1/3")	Ø 14 mm wire:	135 mm (5 5/16")	-
TD-deduction								
Ø 12 mm wire:	110 mm (4 1/3")							
Ø 14 mm wire:	135 mm (5 5/16")							
WL	Cutting measurement. The new forestay wire is to be <u>marked</u> at this point.	=						

Calculating the length of luff extrusion

1. Insert the length of the new forestay wire (WL) as calculated in "Table 1" into "Table 2", in the row marked WL under the heading "Your extrusion".
2. Calculate the number of full length extrusions and the length of the top extrusion.

Table 2: Calculation of luff extrusion length		Your extrusion						
WL	Length of new forestay wire (as per Table 1)							
A + B	Fixed deduction (A+B): <table border="1" style="margin-left: 20px;"> <thead> <tr> <th colspan="2">A+B deduction</th> </tr> </thead> <tbody> <tr> <td>Ø 12 mm wire:</td> <td>-950 mm (37 13/32")</td> </tr> <tr> <td>Ø 14 mm wire:</td> <td>-940 mm (37")</td> </tr> </tbody> </table>	A+B deduction		Ø 12 mm wire:	-950 mm (37 13/32")	Ø 14 mm wire:	-940 mm (37")	-
A+B deduction								
Ø 12 mm wire:	-950 mm (37 13/32")							
Ø 14 mm wire:	-940 mm (37")							
C+D	C+D=							
C	Max. number of 2400 mm (94 1/2") extrusions which together are shorter than C+D: (.....ex x 2400 = C)	C=						
D	<p style="text-align: right;">Length of top extrusion =</p> The top extrusion is normally cut from the 1700 mm (67") extrusion. Round the edges of the cut end using a file. <div style="border: 1px solid black; padding: 5px; margin: 10px 0;"> If the top extrusion is shorter than 700 mm (27 9/16"), the joint will be too near the top. In this case replace the uppermost full-length 2400 mm extrusion with the 1700 mm (67") extrusion. In this way the joint is moved 700mm down the stay. Adjust the C and D measurements as follows: Deduct 700 mm (27 9/16") from the C measurement. Add 700 mm (27 9/16") to the D measurement. </div>							
E	<table border="1" style="margin-left: 20px;"> <thead> <tr> <th colspan="2">E deduction</th> </tr> </thead> <tbody> <tr> <td>Ø 12 mm wire:</td> <td>-510 mm (20")</td> </tr> <tr> <td>Ø 14 mm wire:</td> <td>-560 mm (22")</td> </tr> </tbody> </table> <p style="text-align: right;">Deduction: -</p> <p style="text-align: right;">Length of distance tube E= =</p>	E deduction		Ø 12 mm wire:	-510 mm (20")	Ø 14 mm wire:	-560 mm (22")	- <hr style="width: 50px; margin: 0 auto;"/> =
E deduction								
Ø 12 mm wire:	-510 mm (20")							
Ø 14 mm wire:	-560 mm (22")							

1.3.4. General arrangement

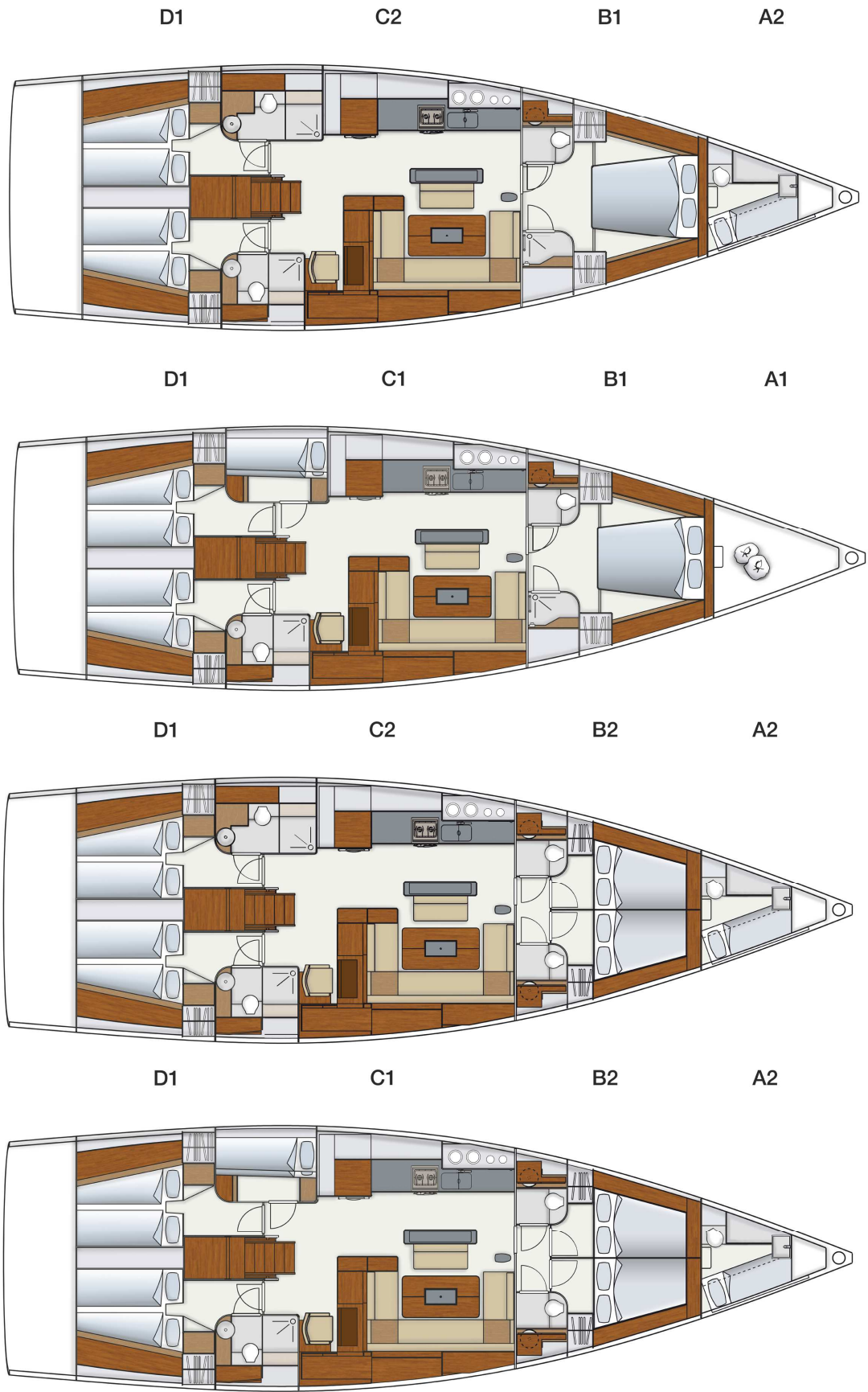

Fig. 2 General arrangement

1.4. Propulsion system

1.4.1. Engine, Engine room, reduction gear

The engine room is located underneath the companionway from the deck to the saloon. The complete propulsion system and all auxiliary equipment, necessary for the operation of the yacht, are located here.

The engine room is separated from living compartments and is ventilated electrical. The engine room is provided with a flame-resistant insulation. The engine room can be accessed either by lifting up the companionway stairs or through a side doors.



Never remove the protections from rotating parts whilst the engine is running. Never touch the rotating parts. Only step on the areas provided for.



The engine room is not stowage space. Do not leave loose objects lying around. Store inflammable liquids in appropriate vessels in boxes or locker seats in the outside area!

1.5. Safety notes

1.5.1. Flooding, watertight integrity

The sailing yacht "Hanse 575" is designed with great care in accordance with state-of-the-art technologies. But outer influences, disoperation or other events can result into flooding and sinking of the boat.

The strength of the hull, its mounting parts and systems is dimensioned such that it securely resists existing strain when travelling in the service areas the boat is designed for.

It is necessary to navigate the boat according to nautical regulations. In some cases, the standard equipment supplied by the shipyard may not suffice.

The craft is equipped with a self-draining cockpit so that water, which entered the boat and rain drains to the outside.

If there is a risk of flooding, the hatches and openings must be shut in any case.



During the voyage, all portlights and deck hatches, especially the cockpit lockers, must be closed and locked!



Shut the cockpit portlights and fix the washboard in order to prevent the ingress of water into the inside of the boat!

Weather conditions to this effect should be avoided, and voyages should be planned according to the weather forecast.

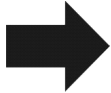
Observe the following notes:**Note**

- Keep order on board so that the systems remain accessible at all times!
- Check the through hull fittings and the ball valves with regard to tightness.
- Make sure that the bilge pumping system is ready to operate.
- Store in your yacht leak stop material!
- Stable buckets are an efficient help for draining.
- Fit the boat according to the weather conditions!
- Close all hatches, windows and portlights in heavy weather (as far as possible)!
- Avoid any technical modifications without consultation by the shipyard!
- Make sure that all inspections and repairs will carry out by specialists!
- Avoid the risk of contact with the sea bed.

1.5.2. Hull openings, seacocks

Openings in the hull are possibly hazards for the penetration of water. They request special attention.

Fittings and cocks were selected according to approved technical regulations and standards. Because they are manual controlled the status of the sea cock should be checked regularly.

**Attention**

All through hull fittings should be revised or replaced latest every 5 years.

All through hull fittings below the waterline can be closed. If you leave the boat close all sea cocks.

For safety reasons the hose connectors are provided with double hose clamps. Do not change this!

Through hull fittings for instruments, i.e. sensor for the echo sounder, are special designed and can not be closed like as a seacock.

**Attention**

Close the sea cocks if they are not in use and between the Sailing.

The status can be recognized by this:

Closed – crosswise lever-direction to the hose

Open – longitudinal lever-direction to the hose

To avert danger you should keep leak stoppers in different sizes on board. They should be made of soft wood in various diameters to fit well into the different sizes of board ducts and could close every opening safely.

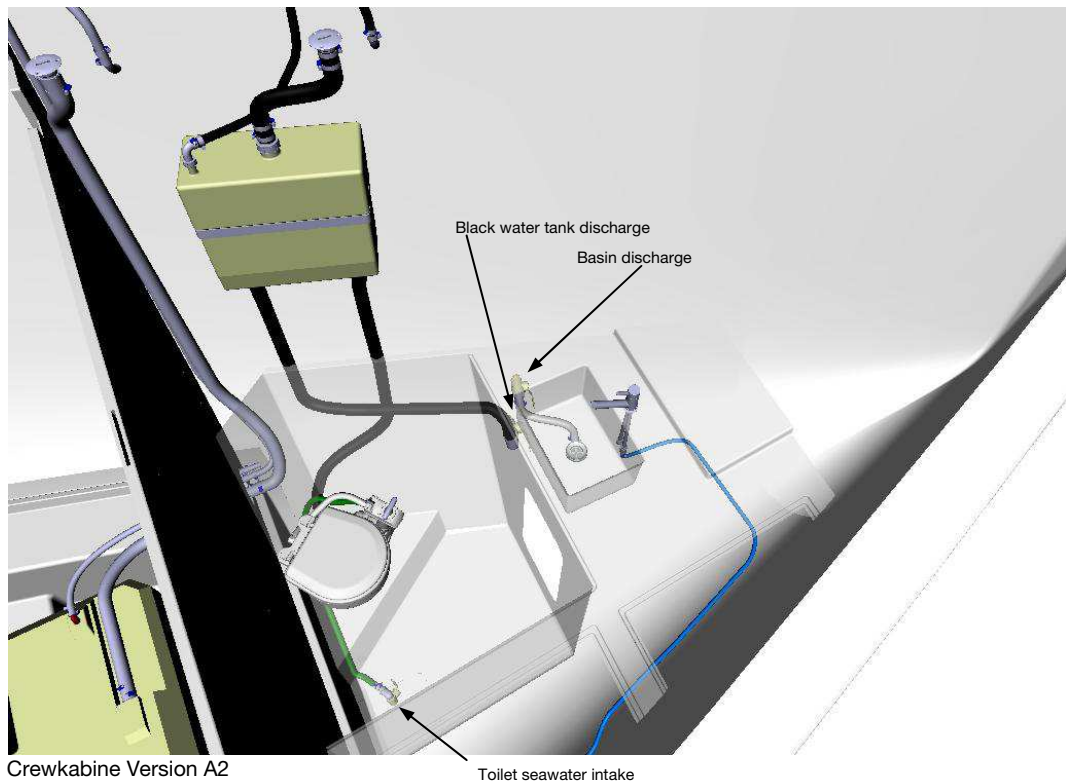
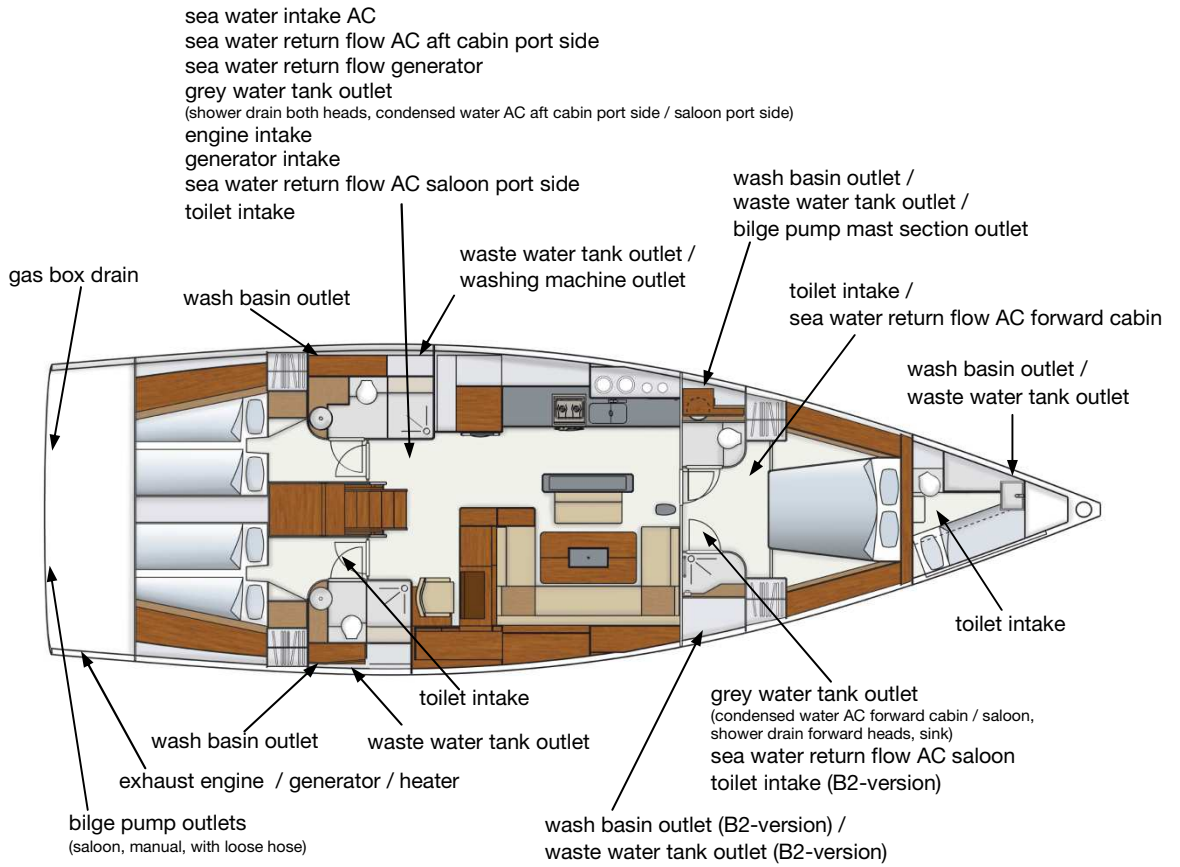

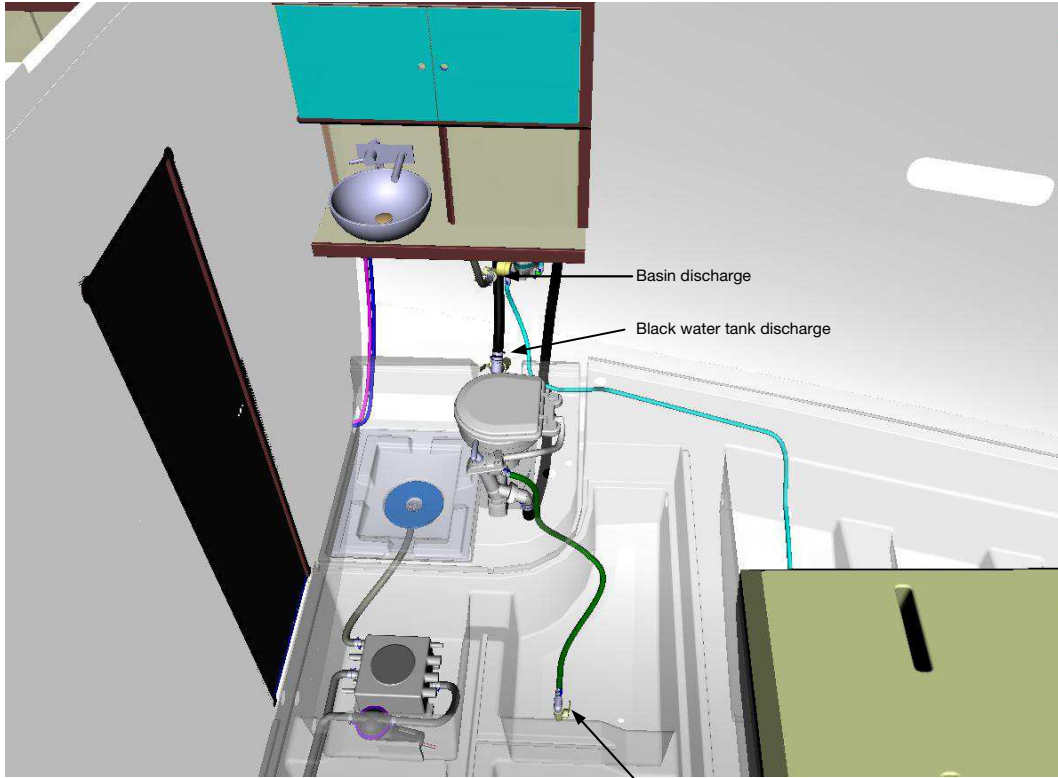

Forward cabin port side

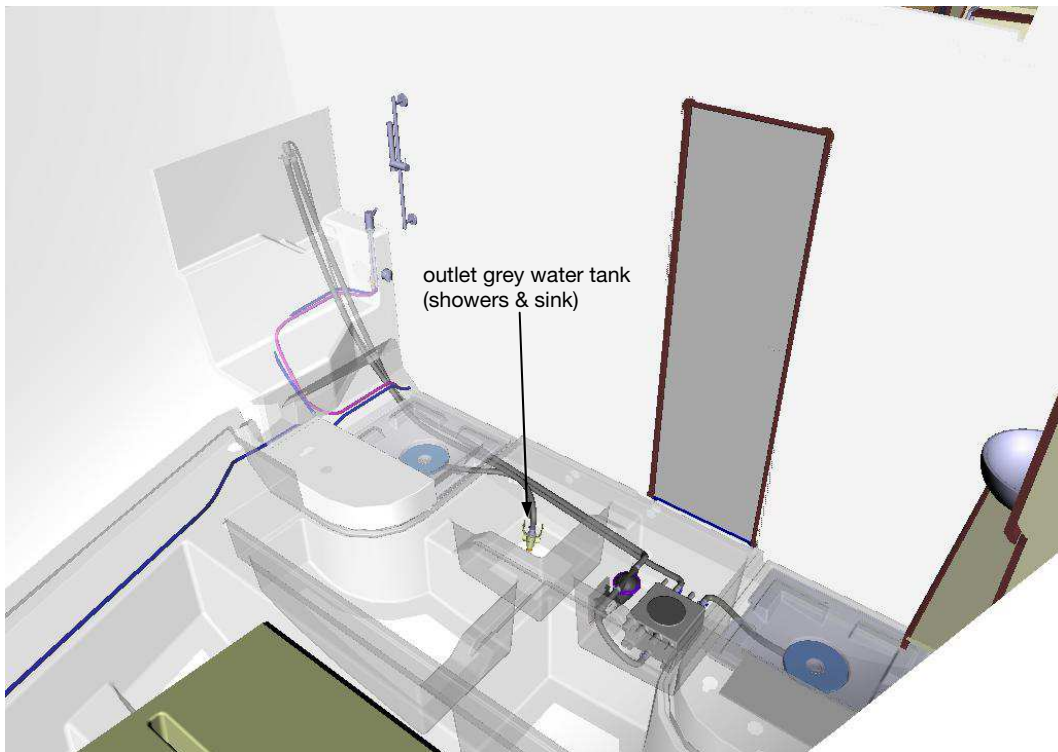

Forward cabin starboard side

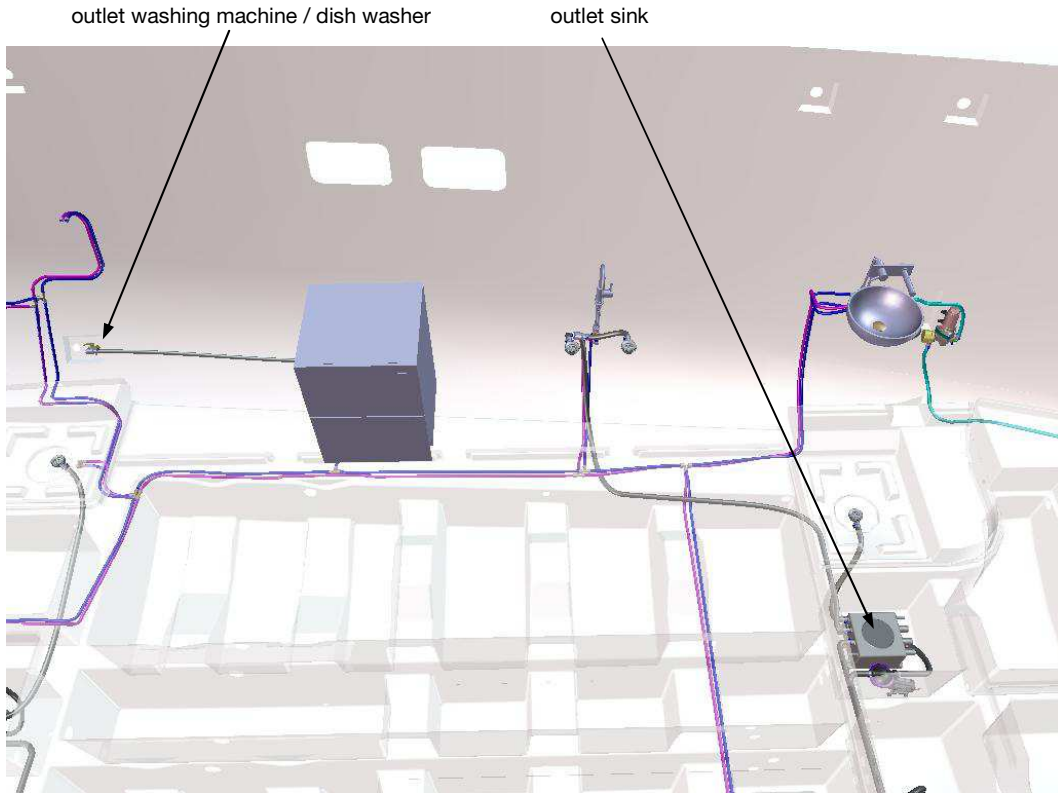

saloon port side

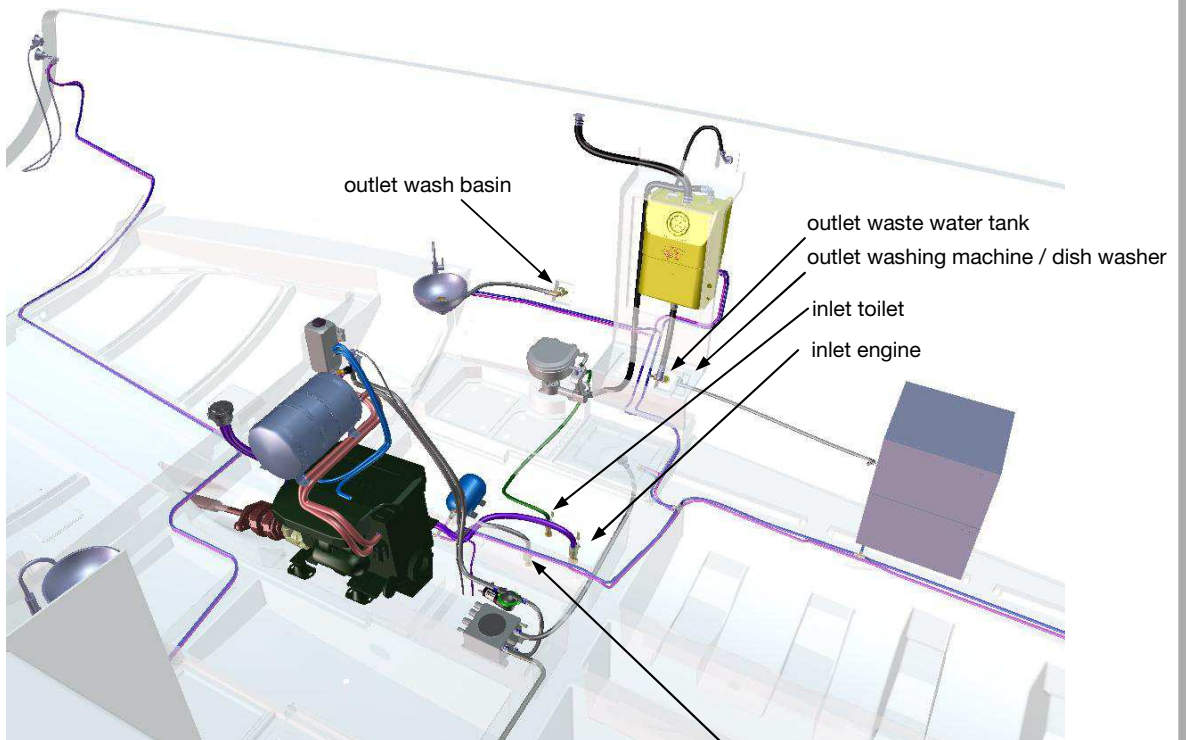

Aft port side

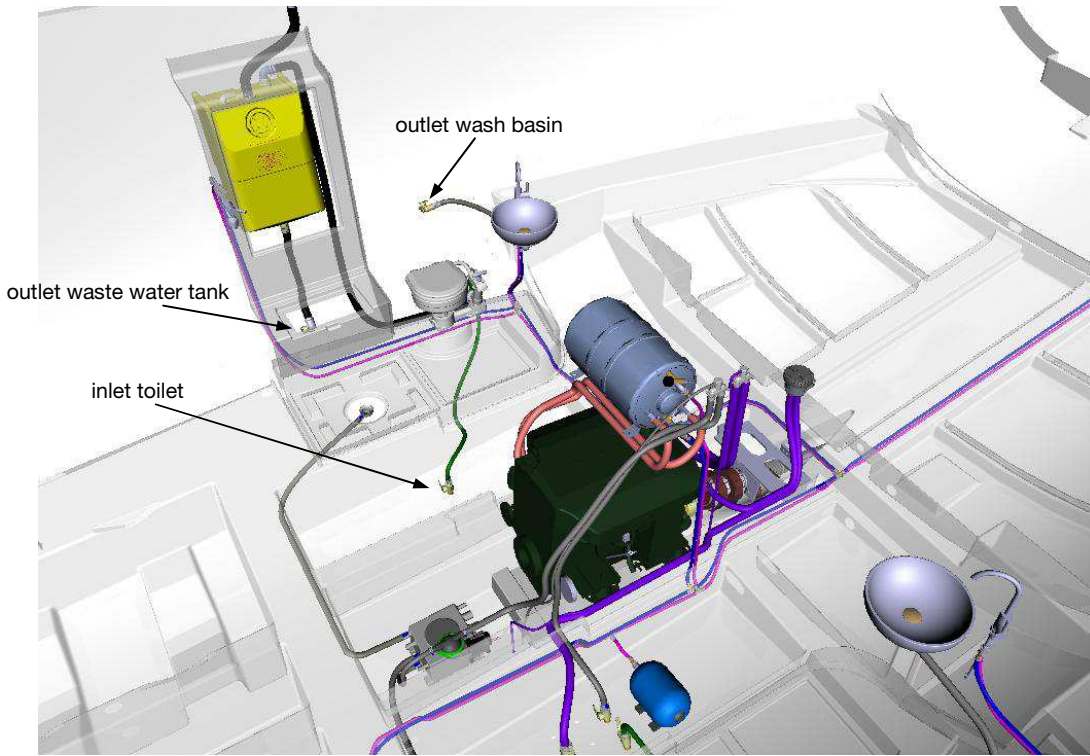

Aft starboard side

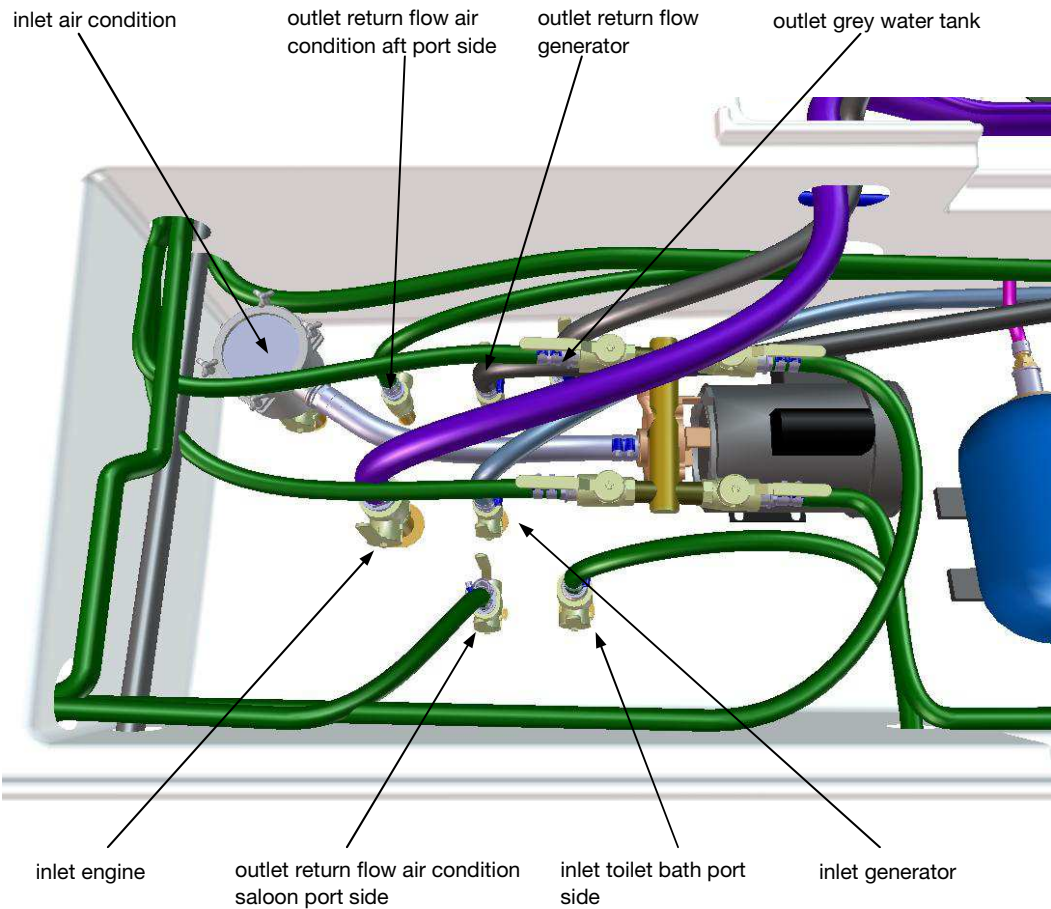

Through hull fittings saloon port side next to the companion way

Fig. 3 Through hull fittings (depending on contract specification)

1.5.3. Stability

Stability is the property of a boat to right up if the boat is heeling in wind and/or waves. This is ensured if there are no significant amounts of water in the boat. Design and distribution of weights are giving the boat sufficient stability.

Any change in the distribution of weights on board can have a considerable impact on the craft's lateral stability, trim and driving characteristics.

1.5.4. Fire protection

Preventive fire protection

Fire is also a big hazard for each boat. A FRP boat is consisting of combustible, but heavy flammable material. We have given the fire hazards great attention. The selection of the materials and the processing are part of this.

The engine room is provided with a flame-retardant sound insulation. This material is fire resistant for a short time.



Warning

During refuelling, the engine, the heating system and the cooker must not be in operation.

Smoking and open fire are prohibited!

The bilges must be kept clean and checked regularly to determine whether they contain oil leakages or fuel and/or fuel vapours. No inflammable material may be stored in the engine room. If you store non-inflammable materials in the engine room make sure that they are protected against falling into the engine installation and must not obstruct the engine room entrance.

We have kept inflammable materials such as curtains away from the cooker unit. Please keep this status. Please instruct your crew how to use the fire extinguishers!



Attention

Essential risks of fire are the engines, the stove and each open flame.



The owner/skipper is responsible for providing portable fire extinguishers. Your sailing yacht must be equipped with appropriate portable fire extinguishers in compliance with the recommendation below at the places marked with the opposite symbol. Please pay attention to regional regulations regarding the number of and provision with portable fire extinguishers. Don't start a voyage before conforming requirements!

They should be located at the following places (Fig. 4):

- | | | |
|-------------------------------------|--|------------------|
| • in the salon on the companion way | dry powder fire extinguisher with hose | at least 5A/34B |
| • max. 2m from the cooker | dry powder fire extinguisher | at least 8A/68B |
| • in all cabins | dry powder fire extinguisher | at least 10A/34B |
| • in the cockpit locker | dry powder fire extinguisher | at least 10A/34B |
| • in the galley | fire blanket | |

CO₂ fire extinguishers are **only** to be used to fight fire in the galley. In all other living compartments the dry powder fire extinguishers are to be used.



Please attend that after discharging of the fire extinguishers the extinguishing agent is in the air. Please ventilate the engine room first before you enter them.

Please complete the equipment with an additional fire blanket in the nearest range of the stove. Fire blankets are very effective to put out burning grease.



The extinguishers have to be checked regularly. Please observe the check periods. Make sure that they are ready to work.

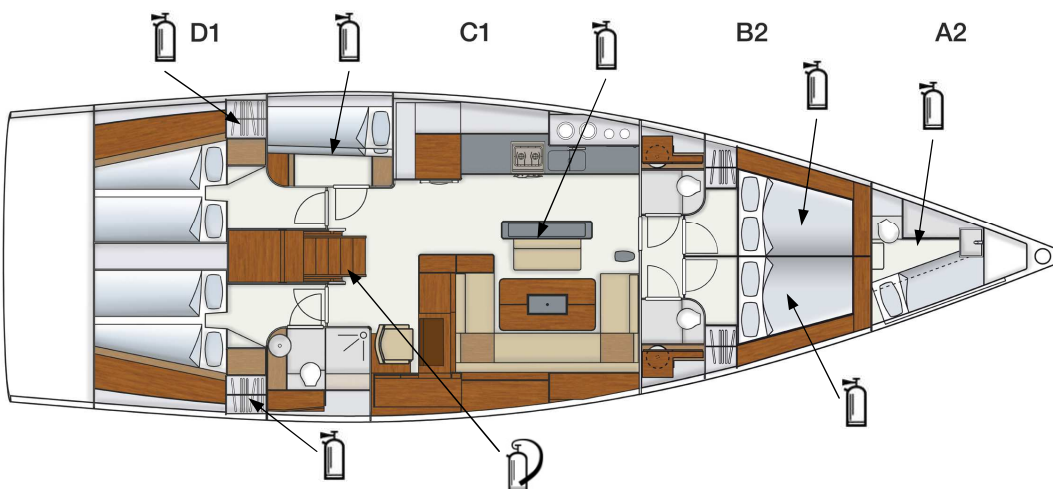

One portable fire-extinguisher in the cockpit locker

Fig. 4 Location of the portable fire-extinguishers

Extinguishers with outdated check period or used extinguishers must be replaced by extinguishers with the same rate and with the same or higher capacity.

Instruct your crew and your guests as to the arrangement and handling of the alarm and fire extinguishing equipment on the yacht. You should additionally include alternative possibilities to extinguish fires such as water buckets, fire blankets etc.

The owner has to inform all persons on board about:

- the position and the operation of the alarm and extinguishing devices;
- alternative extinguishing means like deck wash down, buckets fire blankets etc.;
- the position of the escape ways and escape hatches and doors.

The fire extinguishers should be good accessible.



Attention

Never

- obstruct exits and hatches;
- put in blockings to hatches when persons are on board;
- block safety devices, like for example fuel valves and switches of electrical appliances;
- obstruct fire extinguishers which are stored in shelves;
- let the boat unattended, while cookers and/or heaters are in operation;
- use gas lamps in the craft!
- change technical installations on the boat (especially on the electrical and fuel installation);
- fill the fuel tank if the engine or heaters are in operation;
- smoke or use open lights while handling with fuel.

Active fire fighting



Danger

Each fire is danger for you, the crew and the boat. All persons on board must start fighting the fire with all means and without hesitation immediately after the alarm.

All persons who cannot actively engage in fire fighting should go above deck using the escape hatches and put on their personal life jackets. The burning compartments have to be separated from the atmosphere as much as possible by closing the relevant appliances.

In case of fire in the galley:

- Shut the gas supply valve! (in the locker under the cooker)
- Smother flames with fire blankets!
- If the fire has reached parts of the furniture use the fire extinguishers!

In case of fire in the engine room:

In case of a fire the engine has to be stopped immediately if the nautical safety is not reduced! Do not open the hatches!

- Turn off the engine!
- Shut the fuel valves! (under the floor boards in front of the companion way)
- Do not open the hatches!
- There is a small opening behind the companionway between the steps of the engine room flap. Insert the nozzle of the fire extinguisher here and empty its entire content into the engine room.
- Open the engine room only, if you are sure that the fire is put out, the temperature has been dropped and you are be able to fight flaring up fire again.



Fire on a yacht can turn into a nautical distress. Try to establish radio contact (mayday or pan pan). Keep the distress signals ready.

In case of fire in the engine room, persons not directly involved in fire fighting should leave the inside area via the escape hatch in the saloon or the foredeck cabin.

In case of fire in the other areas

Try to extinguish the fire with the fire blanket or with water if no inflammable liquids are involved. Otherwise, use the fire extinguisher to fight the fire. Use the rescue belt to facilitate the exit via the escape hatch in case of emergency. The escape rescue belt is only to be used in case of emergency, since its use can damage the surface quality of the hatch frame.



The stowage for the rescue belt may not be altered! Free access is to be guaranteed at all times!

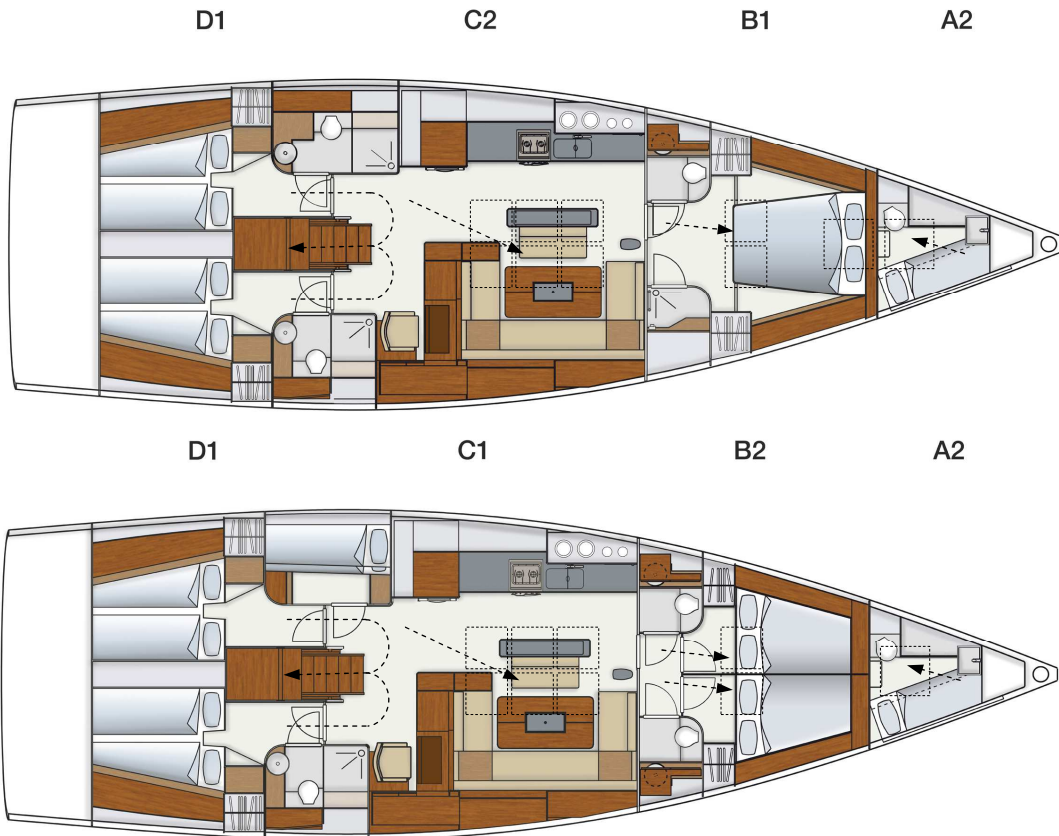

Fig. 5 Escape ways

Safety notes regarding the operation of the liquefied petroleum gas (LPG) unit

The yacht is equipped with an LPG unit. Please observe the following notes when operating it.



Attention

If the system malfunctions, make sure to immediately close the valve in locker under the cooker.

Action in case of a smell of gas

If you smell gas, shut the valve of the gas cylinder and ventilate the boat intensively. The presence of gas fumes can be checked for by means of gas detectors.

Have a specialist examine and remedy the cause before using the gas system again!

Notes on preventing malfunctions of the LPG unit:

- Shut the valves of the supply line and the cylinder if the stove is not in use. In case of an emergency, shut the valves immediately.
- Make sure that the valves of the appliances are shut before opening the valve of the cylinder!
- Check the LPG unit for possible leakages before use:
Shut the valves of the appliance; open the valve of the cylinder; wait for stabilisation from the pressure; shut the valve of the cylinder; watch on the manometer for 3 minutes; the pressure should remain constant!
If pressure gauge reading falls, leak is present: do not use LPG appliances!
- Manual leak testing with foam-producing, soapy water or detergent solutions (with appliance burner valves closed and cylinder and system valves open); foam-producing solutions for leak detection on gas installations in accordance with EN 14291 meet these requirements;
- If there are leakages, shut the valve of the cylinder and have the system repaired by a specialist before using the appliance again.



Warning

Fuel burning open flame appliances consume cabin oxygen and release products of combustion into the craft. Ventilation is required when appliances are in use. Open designated vent openings while appliances are in use. Do not use the stove or oven for space heating. Never obstruct ventilation openings.

- Never block access to the LPG system.
- The valves of empty cylinders must be shut and disconnected from the system. Keep lids and sealing caps ready for use. Store reserve cylinders and empty cylinders on the open deck or in the provided spaces that have outboard ventilation!
- Never use the lockers or boxes meant for the gas cylinders to store other equipment!



Warning

Never leave craft unattended when open flame LPG cylinders. Close cylinder valves on empty cylinders before disconnection for replacement.

- Check the hose assemblies of the LPG system on a regular basis, at least once a year. Have them replaced if they are damaged.
- If you replace the stove, make sure that the new one has the same working pressure.
- Never use the stove in case of high waves or large heel angles (if the boat is not equipped with a gimballed stove)!



Note

Comply with the inspection intervals of the entire system! The inspection should only be carried out by a maintenance firm specialised in LPG systems on boats.



Note

If the boat is sailing under the German flag, you, as owner, are obliged that the gas system will be inspected every two years by a specialist of the "Deutscher Verband der Gas- und Wasserinstallateure mit der Zulassung für Caravane und Boote".

Please observe the following notes and the manuals or operating instructions of the appliance manufacturers!



Danger

Escaping gas is heavier than air. It accumulates in the hull. In this case there is a **risk of suffocation and explosion**. If you smell gas, never use fire or unsafe light or electrical devices!



Attention

- Never use solutions containing ammonia to check the conduit.
- Never use an open flame to search for leakages.



Warning

Do not smoke or use open flame when replacing LPG cylinders. Close cylinder valves on empty cylinders before disconnecting for replacement.

1.5.5. In-Mast furling mainsail

When furling the mainsail the backstay tension should be released.

This supports the roller mechanism and helps reduce wrinkles when furling the sail.

Additionally, the reefing winch lever at the mast must be in the correct position.

If the furling mechanism is unusually sluggish, stop the furl immediately and check the mechanism.

The mainsail furling rope should never be driven via an electric winch.

After furling the backstay should be re-tensioned.



Chapter 2 – Further Technical Details

1. Installations and Systems

1.1. Tank capacities

2 Fuel tanks	approx. 540 l	The tanks are located underneath the floor boards in the saloon. They are equipped with electrical transmitting devices and ventilation.
1 Fresh water tank	approx. 770 l	The fresh water tank is equipped with an inspection lid, valves and ventilation. The tank is located under the bed in the bow.
Black water tanks	approx. 85 / 35l	<p>The tanks are located in the immediate vicinity of the toilet.</p> <p>The tanks are permanently installed. The system includes appropriate valves and deck openings to pump-out the content on shore and a seacock for direct discharge into the sea.</p> <p>The 85l tanks are located in the bath rooms from the aft cabins and the 35l tanks are in the forward bath rooms.</p>



Note

In the fixed fuel and water tanks, it is possible that all the capacity may not be usable according trim and loading. In the fuel tank, a reserve of 20% should be kept.

1.2 Water systems

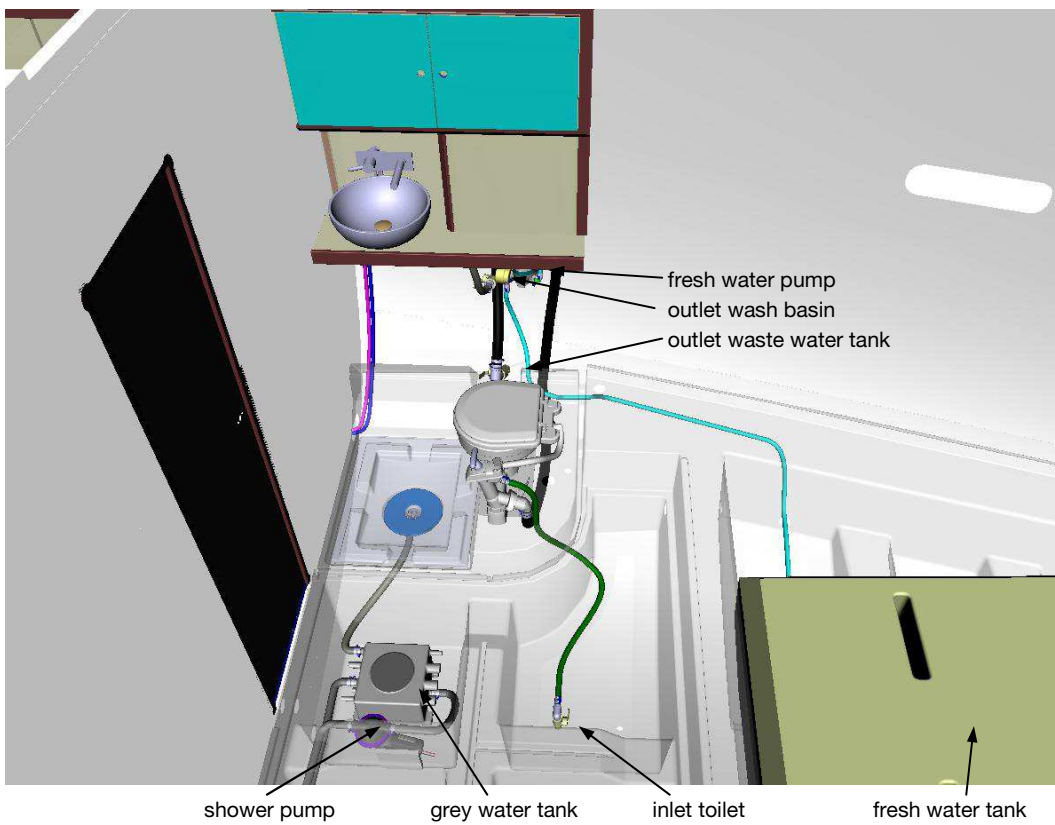
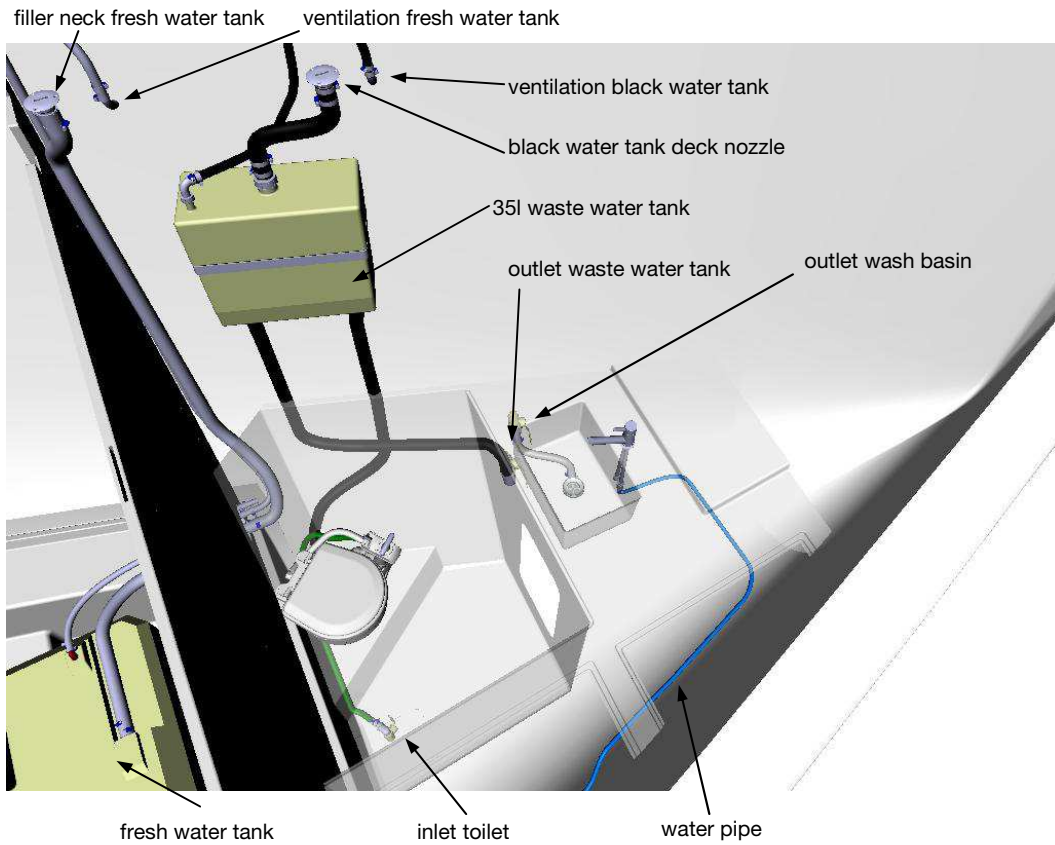

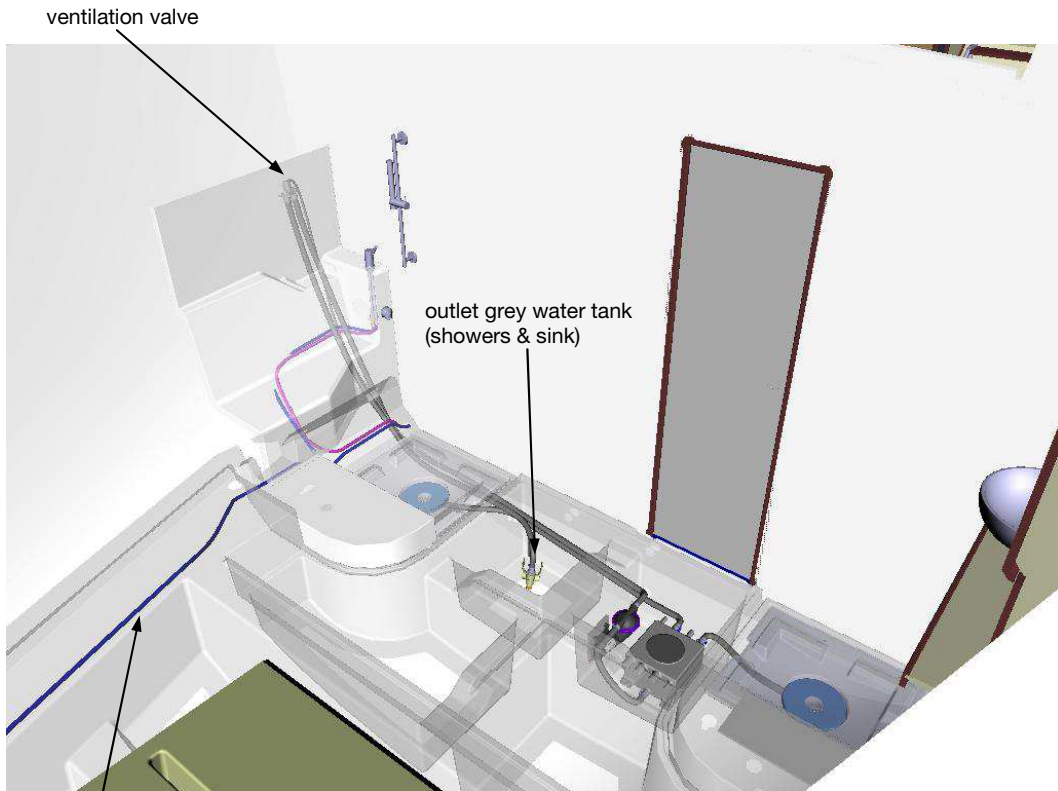

ventilation valve

outlet grey water tank
(showers & sink)

water pipe to crew cabin
(Version A2)

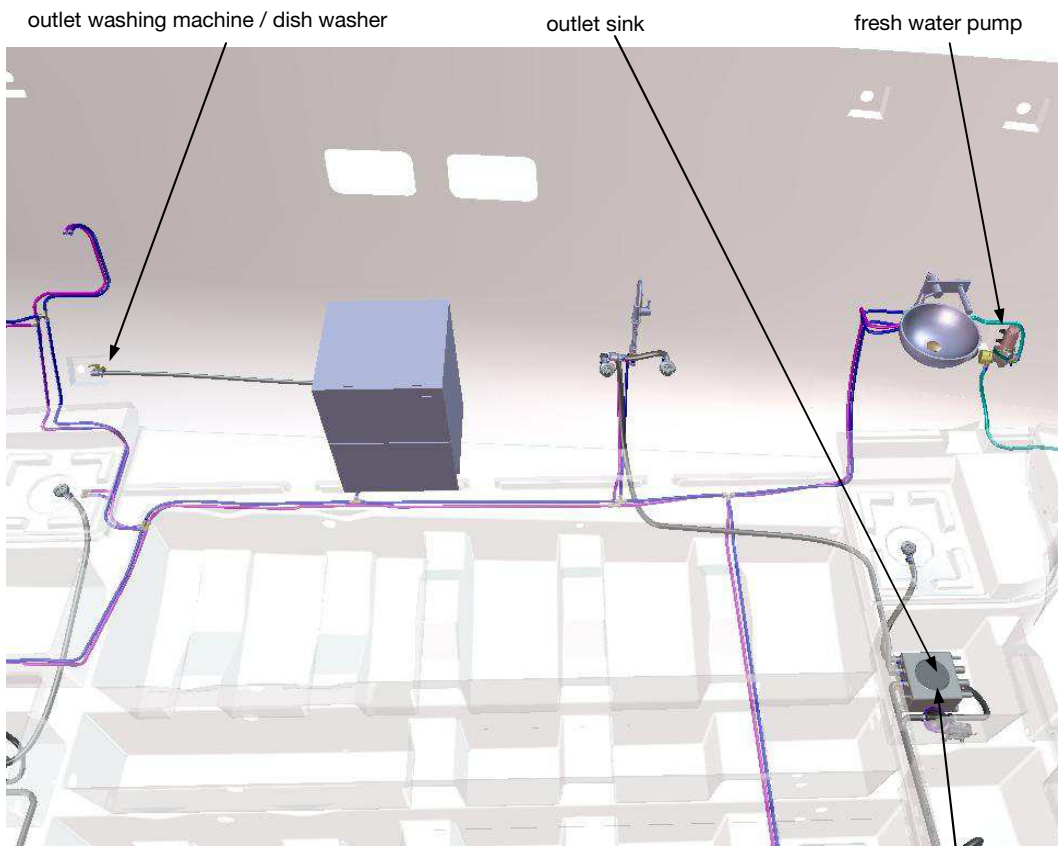

outlet washing machine / dish washer

outlet sink

fresh water pump

grey water tank & pump

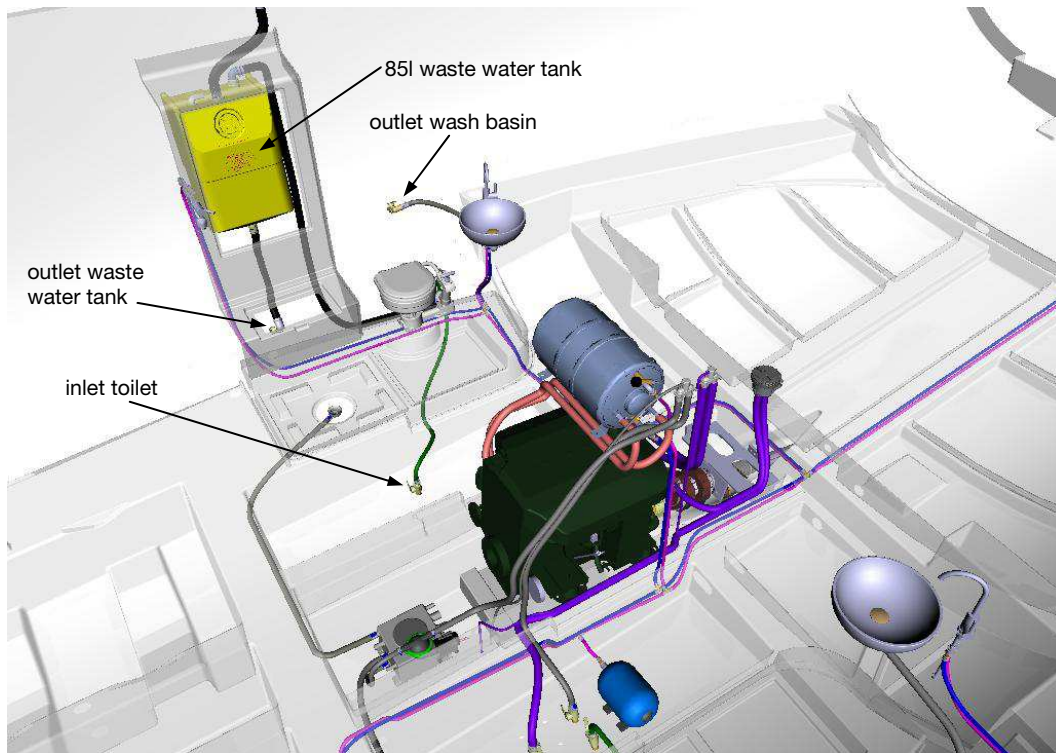
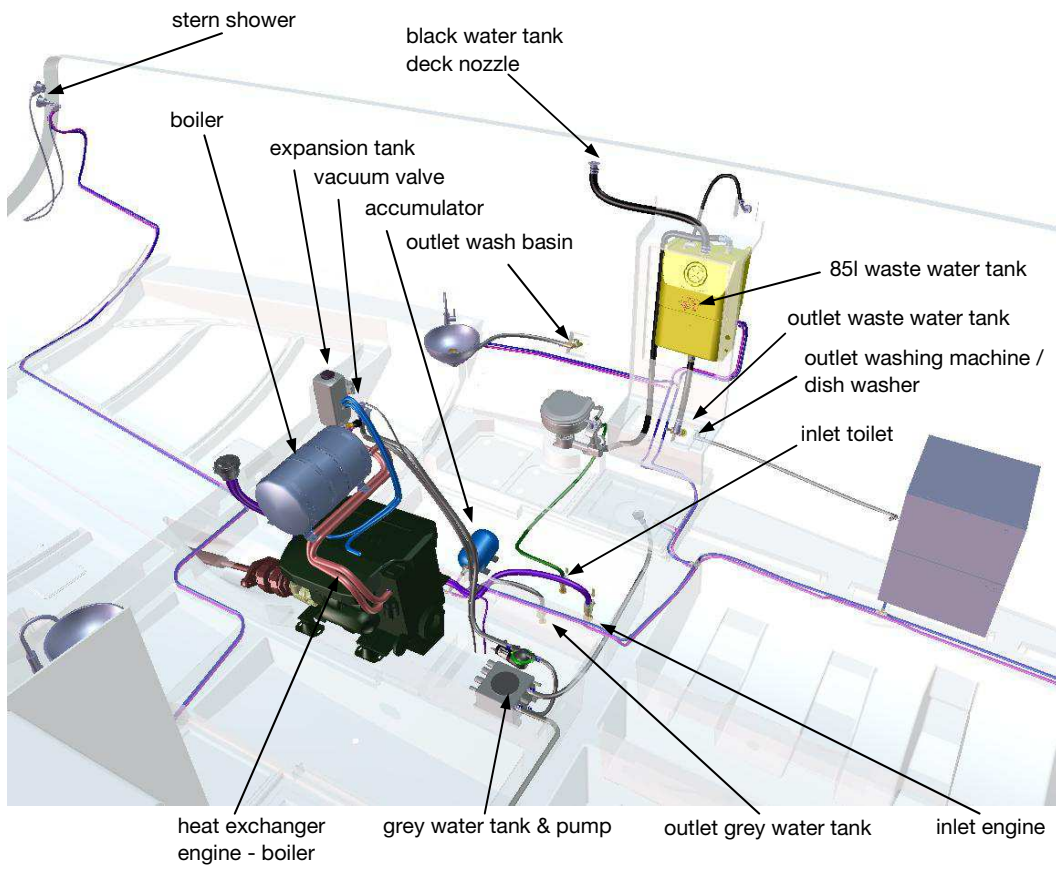

1.2.1. Drinking water

The yacht has 1 water tank with a total capacity of approx. 770 l.

The filler neck for the freshwater tank is located on the foredeck on the port side.

Before filling, check whether the marking on the filler neck is correct.

The pressure water pump (12 V) in the forward port side bath draws the water from the tank and feeds cold water to the taps. When taps are opened, the pump is activated. When they are shut, the pump is switched off by the counter-pressure.

Should the pump continue to run, the system must be checked for leakage.



Note

If air bubbles come from a water tap, immediately switch off the corresponding pressure water pump at the distribution fuse panel. The pumps are safe to run dry for a short period of time. When running dry for a longer period of time, the pump may be damaged.



Attention

If drinking water is stored for a longer period of time, disease-causing bacteria can develop. Use appropriate and approved agents to protect against bacteria. Change the water frequently and rinse the tank.

An electric boiler is installed to make hot water. The cold fresh water is supplied via the pressure pump. Due to the pressure drop in the cold water system when filling the boiler, the pressure water pump automatically switches on.



Note

Empty the complete system, the electric boiler and the tanks if there is a risk of temperatures below freezing.



Attention

Do not switch the electric boiler on if there is no water in the system. Otherwise, the heating element can be damaged!

1.2.2. Seawater

Seawater is used for two circuits:

- for the engine system (refer to section 1.7.4)
- for flushing the toilet
- air condition (option)
- generator (option)



Attention

The seacocks must be shut after use!

Clean seawater free of impurities is necessary for the faultless operation of the systems. Therefore, check the seawater filter on a regular basis, and clean or replace the filter pads if necessary.



Ensure that the filter lids are properly fastened and that the hose clamps are properly fixed, otherwise there is a risk of water penetration.

1.2.3. Black water

Black water designates all sewage from the toilets. Seawater is used for flushing. It is pressed into the bowl and pumped into the black water tank with the contents of the bowl.

The black water tanks with a total capacity of 35 litres and 85 litres are a permanent installed tank in the immediate vicinity of the toilet. The tank's ventilation ends in the boat's side.

The tank is emptied either via the respective pump-out deck fitting with the help of a suction plant on shore or outboard via the seacock. Please check whether the hoses are compatible with the use of chemicals.

Before leaving the port, make use of the available pumping facilities to empty the black water tank in any case.

Emptying using deck nozzles

The pump-out deck fittings are located on deck and marked "Waste".



Please make sure that the ventilation of the black water tank is ensured; otherwise the system could be damaged when emptying the tank.



When pumping out the tank, keep to the following sequence:

- Open the deck screwing, insert the suction nozzle
- Suck out/pump out
- Fasten the deck screwing.

Emptying via seacock

To empty the black water tanks outboard, open the seacocks. After pumping out, shut the seacocks again.



Please note that there are regulations for certain ports and shipping routes where it must be ensured that no sewage can be pumped outboard (e.g. the Baltic Sea Convention). Instruct your crew and guests how to deal with this.



The toilets and the black water tanks may not be drained near the coast or in any protected area (see also 3.8)!

In this case, the outboard discharge can be locked and sealed.

Operating the system

Observe the symbols at the toilet to use the WC. Never throw solid or clogging materials or objects into the toilet.



The electric toilets (option) are not usable in case of insufficient battery capacity or of faulty electrical system.

Maintenance of the system

Never use aggressive liquids, aggressive cleaning agents or deodorants to clean the system because they may damage the conduit.

Never use pure antifreeze agents when getting the system ready for winter storage. If necessary, contact your dealer. Always completely empty the system in case temperatures below freezing are expected.

See also supplied manufacturer's instructions.

1.2.4. Bilge system

The anchor locker and the cockpit are self-draining so that no pumps are needed here. The openings must be kept free of blockages.

The yacht is equipped with a manual and 3 electrical bilge pumps, each with a capacity of at least 30 l/min. Their functionality is to be regularly checked.

The manual bilge pump is located at the helm position in the cockpit. The electrical bilge pumps are accessible through the floor boards.

The electrical bilge pump can be operated in two modes:

- Automatically - the pump switches on if the bilge has reached a certain level
- Manually - the pump is operated manually from the operating panel of the bilge pump.

Please pay attention to whether the valves are open or shut. Take special care to ensure that the bilge in the engine room is free of oil.

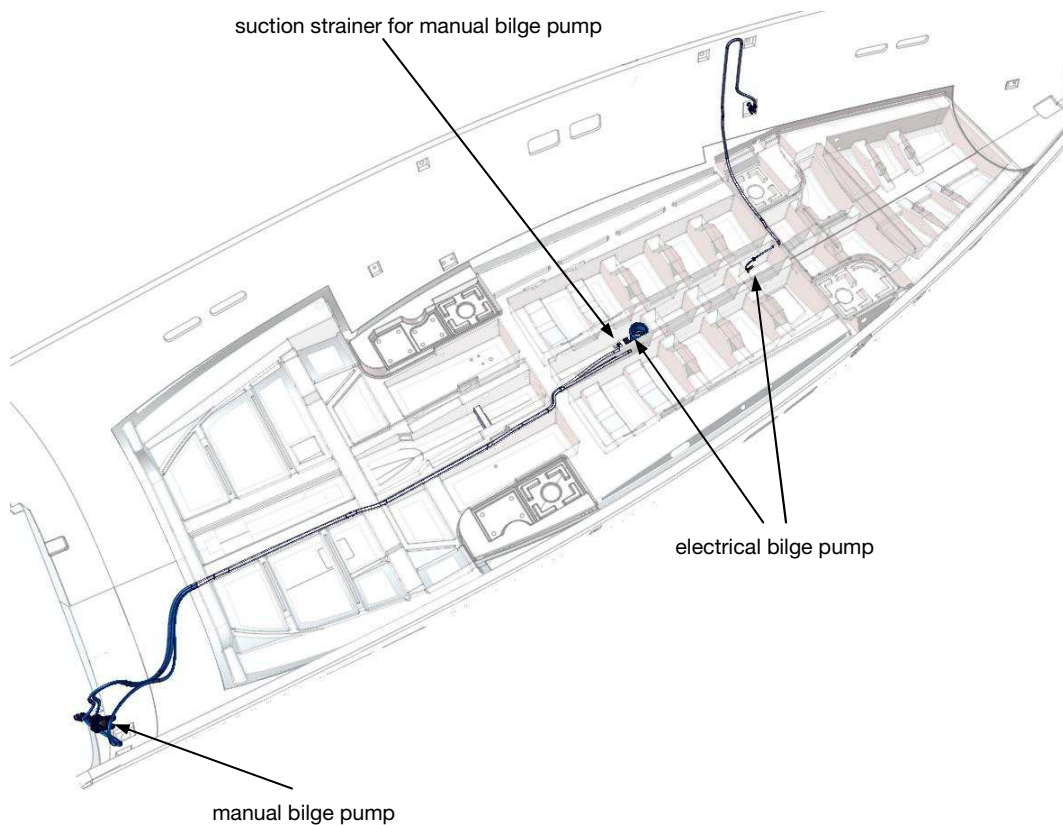

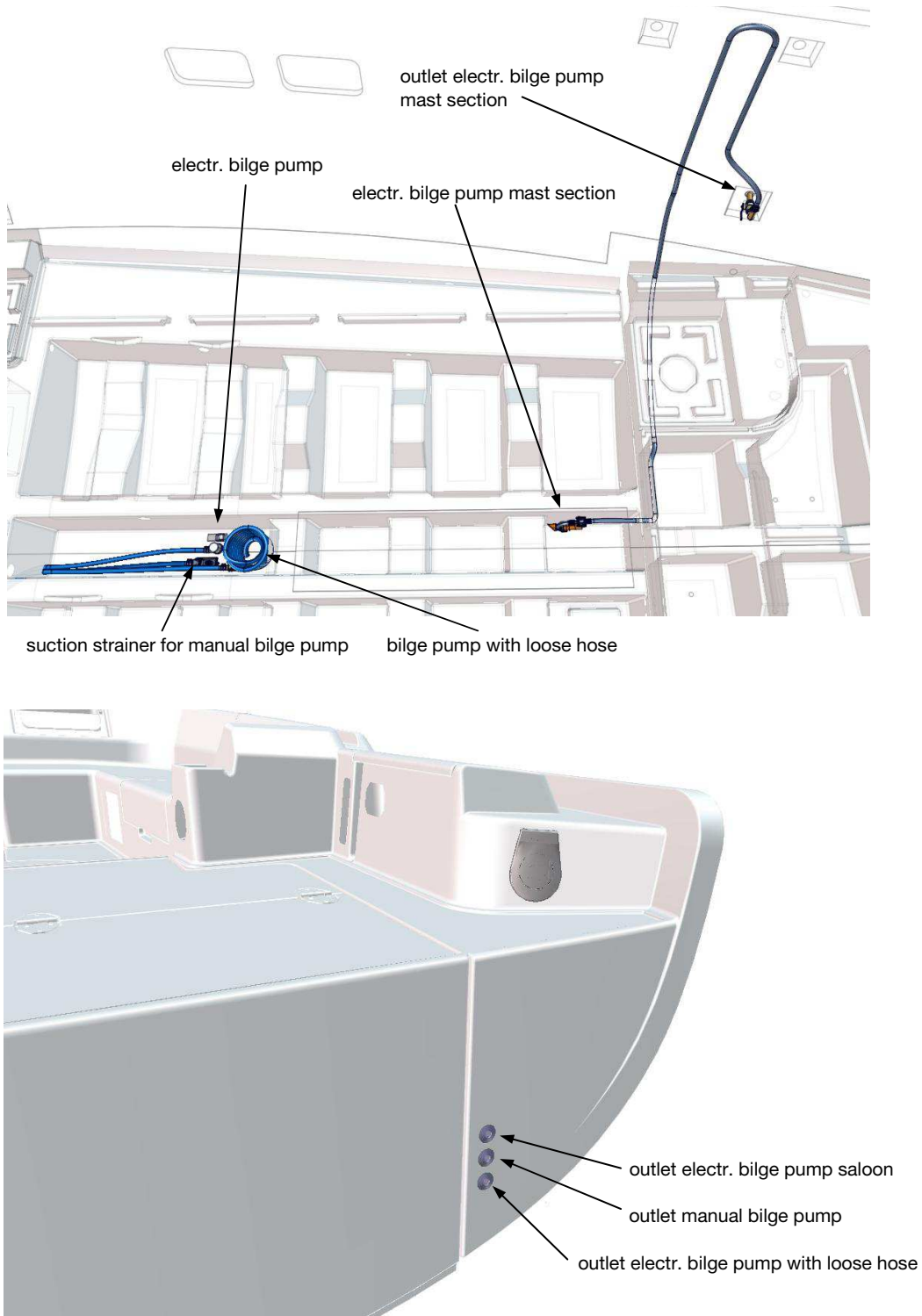

The functionality of all bilge pumps is to be checked regularly. The intakes of the pumps are to be cleaned of dirt.



The bilge system is not designed for damage control. See Section 1.5. "Safety Notes".

The boat should be additionally equipped with a bucket on a rope or a bailer.

See also supplied manufacturer's instructions.

1.3. Fuel system

The fuel tanks with a total capacity of approx. 540 l are located underneath the floor boards in the saloon. They can be filled through the filler neck marked "Fuel" or "Diesel" located on the side deck. To do so, unscrew the lid. Check whether the ventilation openings are free.

The level can be checked at the main control panel.

The fuel reaches the engine via a suction pipe and a preliminary fuel filter with a water separator. Due to the short lines, the system consists of fire-resistant fuel hoses.



Attention

The tank intended for the fuel supply can be switched via a three way cock. Ensure that the respective valve on the tank is open. Ensure that the return is done on the extraction tank.

Please note that the return lines are always open to ensure the return to the tank.

Fuel refilling

The boat should be refuelled carefully so that no fuel spills onto the deck or into the water. Keep an oil absorbing cloth at hand. Open the cap and insert the funnel or the fuel nozzle. Take care to establish contact with the filler neck (earthing). Then start refuelling.



Attention

Refuel only from the engine manufacturer recommended kind of fuel (diesel)!



Note

Only refuel clean fuel. Check and cleanse the filter and the water separator regularly.

The skipper is responsible that no fuel comes into the water. This can only be prevented if the fuel gauge is constantly monitored by a second person during the refueling process. In addition the refueling should be stopped early enough, to prevent the fuel from entering the fuel vent line.

When filling the fuel tank, be aware that at least 5% of the volume should remain free, in order to prevent leakage from the tank ventilation line

Keep the tank vent thru hull in sight when filling the tank, because fuel could spill out of this area

Due to differences in fuel quality, fuel can become foamy while filling. For this reason, always use care and slowly fill the fuel tank



Attention

Environmental Protection:

Under no circumstances overfill fuel!

Tank closure in an emergency situation

In case of fuel line leakages or fire in the engine room, the tanks can be shut off by means of a valve on the tanks.

Always take care that no fuel spills or leaks into the water. Fuel that has leaked out or spilled must be cleaned up and disposed of in an approved and environmentally friendly manner.

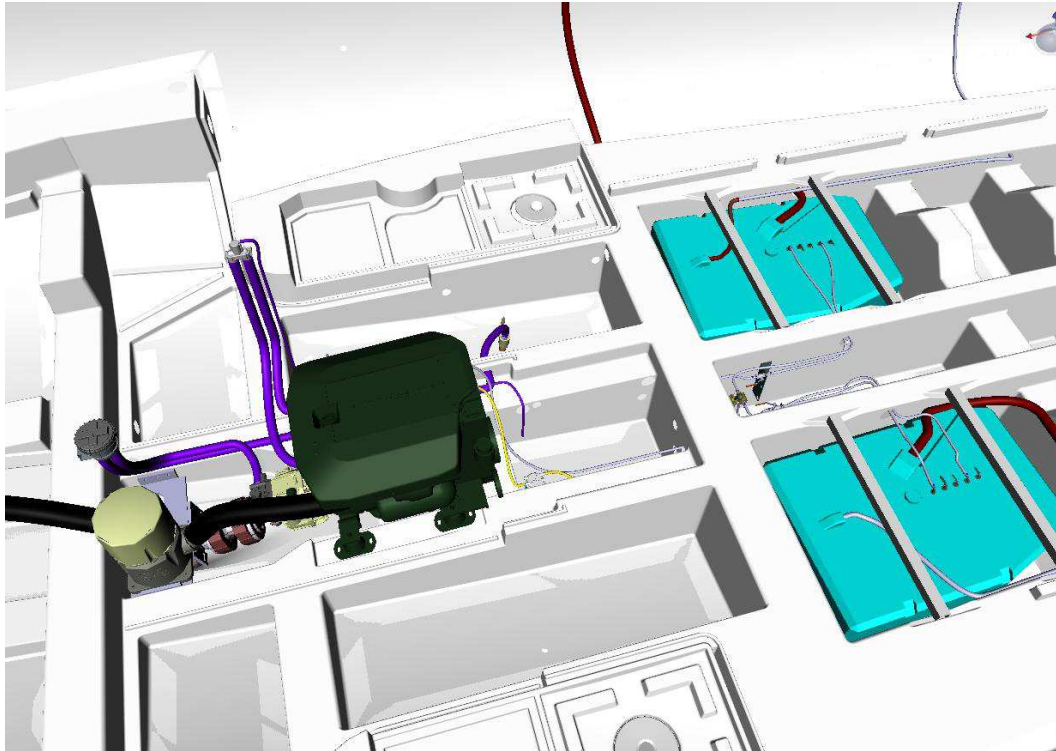
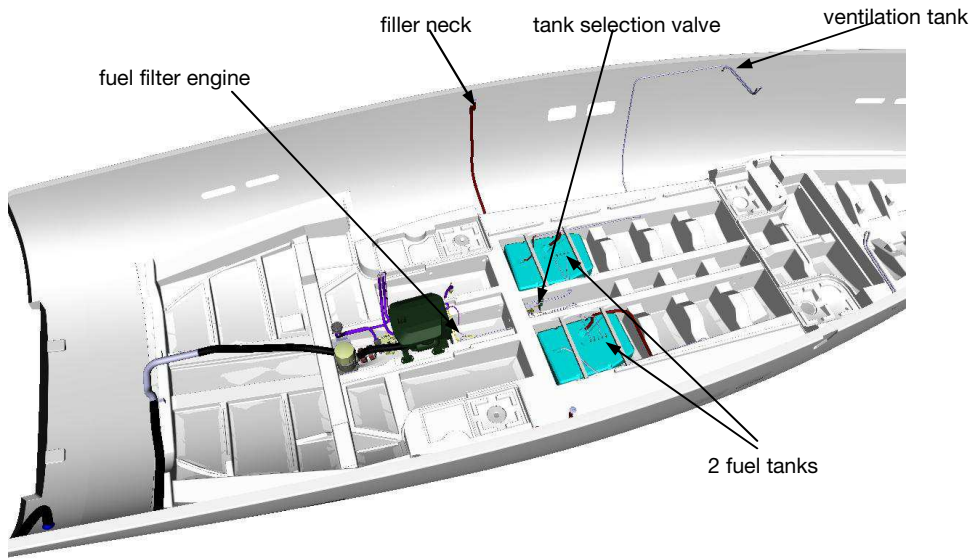

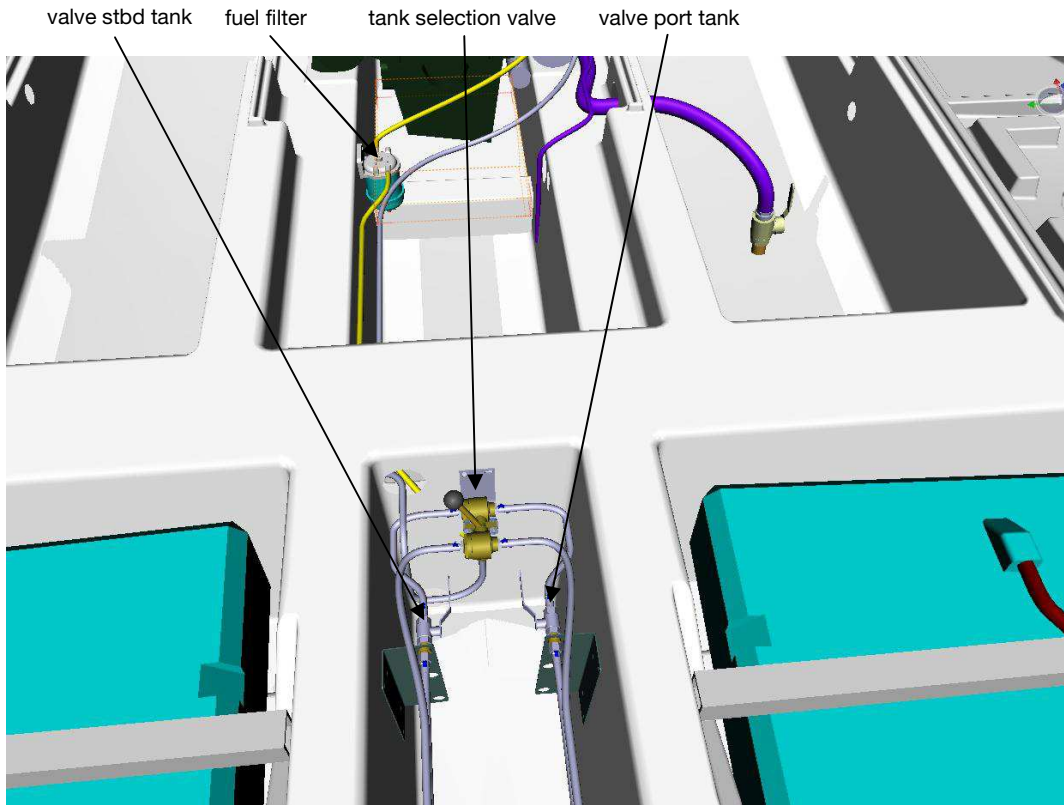

Fig. 6 fuel system

1.4. Steering system

The rudder is a semi-balanced rudder with self-aligning needle roller bearings. The boat can be steered by means of the steering wheel from the cockpit.

The steering system is accessed through the starboard hatch in the dinghy garage and through hatches in both aft cabins.

The chain-wire steering with the gearbox and tiller arm turns the rudder to port and starboard side.

The steering system is a redundant system of that no emergency tiller is on board.

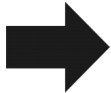

Note

The post must have no clearance but should not need heavy movements.

The wires stretch after the first large loads. If necessary tighten the wire near the gearboxes.

The wire should not be loose, but also not too tight. The steering system should be tightened at least annually, or if a situation is created, where something is not performing optimally (see Maintenance section 4.7). Metal dust near the sheave often indicates unnatural wear.



Attention

During reverse movement, the rudder can cause a movement with enormous force.

The rudder blade is made of a grp body with laminated rudder stock.

The shaft runs in two special self-adjusting rudder bearings.

Rudder bearings will always be subject to wear and must be therefore subject to regular inspection and maintenance.

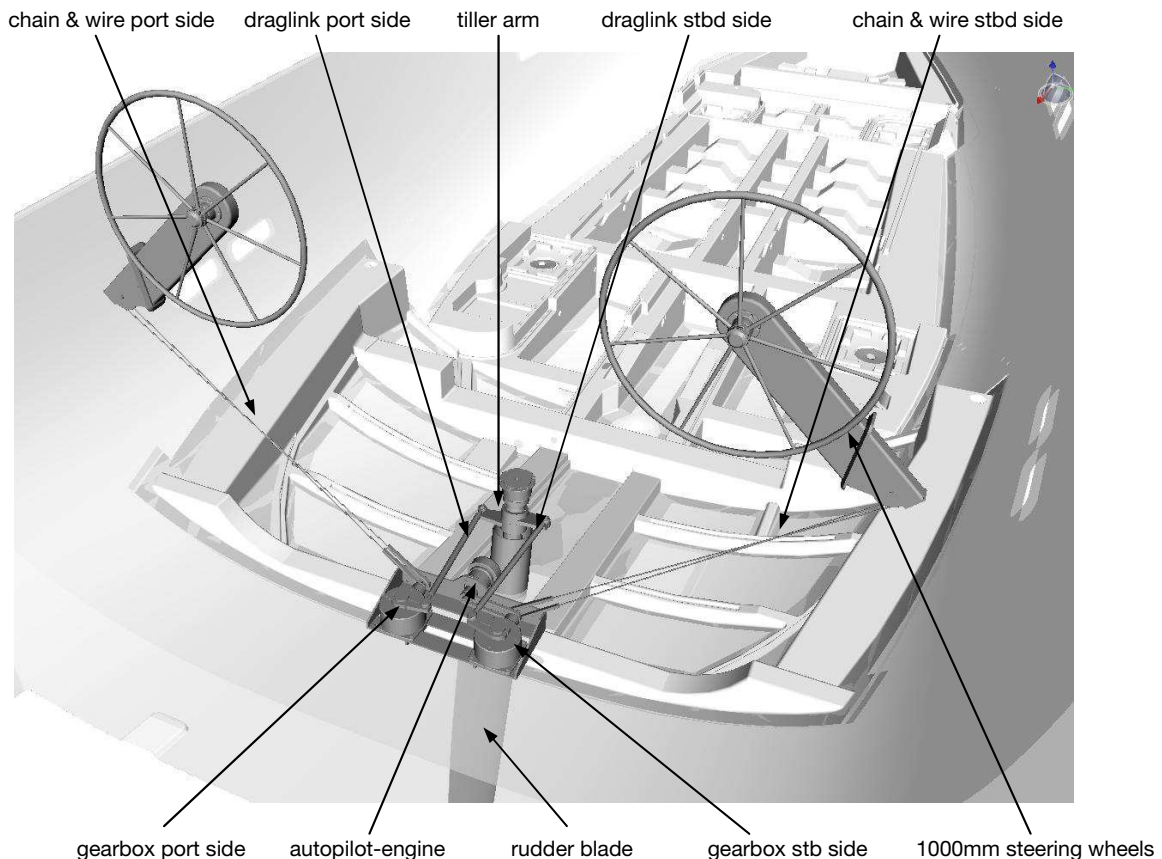

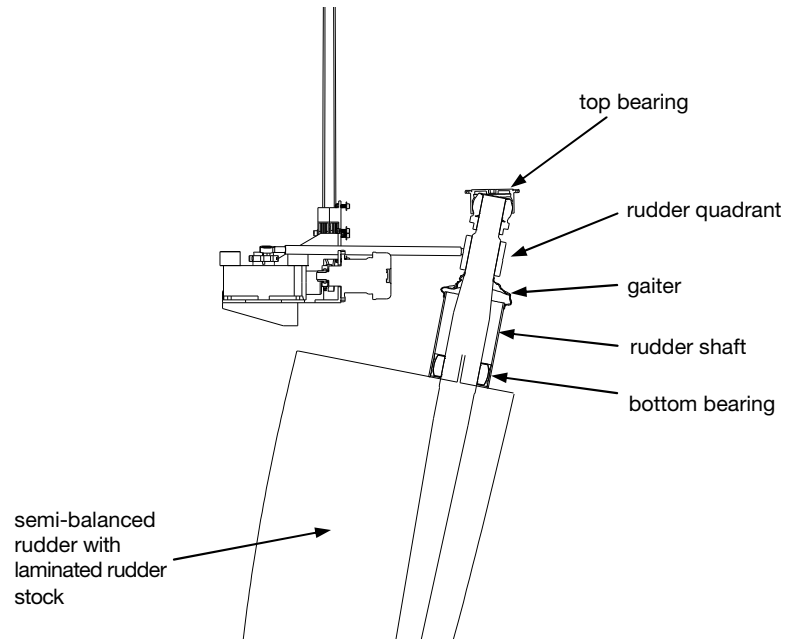

If there is a failure in the steering system, you can operate the rudder with second steering wheel.

- Open rudder spaces and check the steering mechanism.
- If necessary demounting the draglink from the failure system between gearbox and tiller arm.



Note

The rudder compartment is not a stowage place for equipment or other objects.

Moveable components of the steering system should be treated with water-resistant greases within the scope of winter overhauling.

1.5. Electrical systems

The boat possesses two electrical systems: 12 V direct current and 230 V alternating current.

Information on the scope and the equipment can be found in the operating instructions and the contract specification. Take note of the operating instructions that include circuit diagrams for the electrical systems and devices!

The electrical systems can be switched and controlled via the respective main control panels.

The main switches for the service batteries, the main fuses and additional fuses are located in the navigation area and in the battery box in the salon on the starboard side.



Attention

When operating the engine the main switches may not be switched off, since this would destroy the diodes of the alternator.

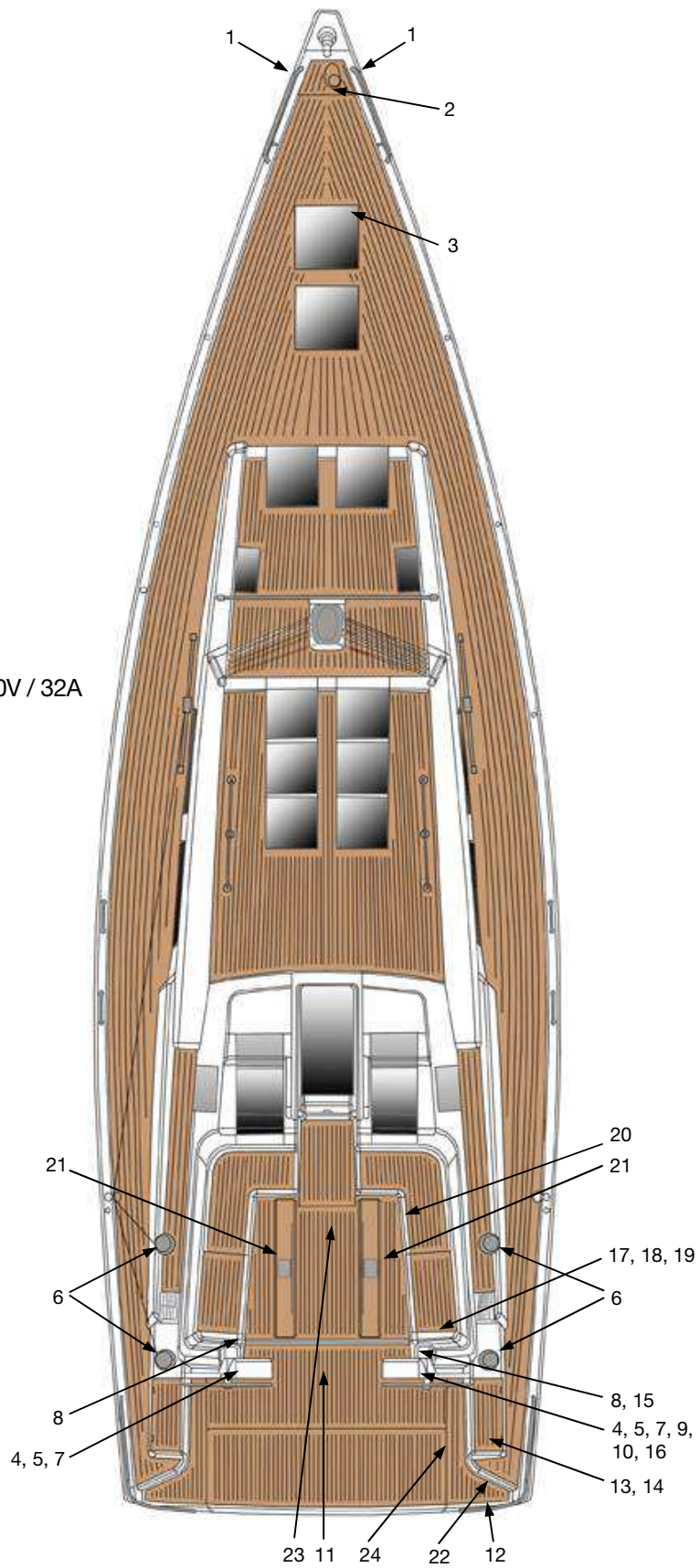

Fig. 7 fuses navigation area

Label power panel	Appliance	fuse
F100	relay vent engine room	50A
X8.1	DC-panel	50A
X8.2	anchor winch	80A
X8.3	elec. halyard winch	125A
X8.4	elec. halyard winch	125A
X9.1.1	sense battery charger	2A
X9.1.2	night light	5A
X9.1.3	bilge pump 1	10A
X9.1.4	bilge pump 2	10A
X9.1.5	condensation water pump Aircon 1	10A
X9.1.6	condensation water pump Aircon 2	10A
X9.1.7	bilge pump 3	10A
X9.2.8	radio	10A
X9.2.9	VolvoRelais	5A
X9.2.10	VolvoRelais	5A
X9.2.11	VHF	10A
X9.2.12	Gangway	10A
X9.2.13	radio	10A
X9.2.14	bilge pump 4	10A
X9.3.15	sense service battery	2A
X9.3.16	radio	10A
X9.3.17	12V socket	10A
X9.3.18	12V socket	10A
X9.3.19	fridge cockpit	15A
X9.3.20	shower pump	10A
X9.3.21	elec. toilet	30A
X9.4.22	elec. bathing platform / engine lid	15A
X9.4.23	trim taps / smart mooring system	15A
X9.4.24	LP gas remote switch	5A
X9.4.25	switch bank steering pedestal	30A
X9.4.26	elec. table / vent	10A
X9.4.27	12V socket	10A
X9.4.28	elec. toilet	30A
X9.6.36	shower pump 1	10A
X9.6.37	shower pump 2	10A
X9.6.38	shower pump 3	10A
X9.6.39	shower pump 4	10A
X9.6.40	shower pump 5	10A
X9.6.41	bow thruster	15A
X9.6.42	stern thruster	15A
X9.7.43	elec. toilet	30A
X9.7.44	elec. toilet	30A
X9.7.45	elec. toilet	30A
X9.7.48	multifunction antenna	10A
X9.7.49	radio	10A
X12.1	under water light 1	20A
X12.2	under water light 2	20A
X12.3	vent engine room 2	10A
X12.5	vent engine room 1	10A

Overview electrical devices on deck

1. navigation lights
2. anchor winch
3. anchor winch control
4. navigation instruments
5. plotter
6. E-winch & control
7. compass
8. speaker
9. engine panel
10. rotation speed indicator
11. engine autopilot
12. navigation light
13. shore connection 230V / 16A
14. second shore connection 230V / 32A
15. radio control
16. bow-/ stern thruster control
17. galvanic isolator
18. computer autopilot
19. earth leakage circuit breaker
20. refrigerator
21. electr. cockpit table
22. stern flap control
23. dinghy-winch
24. compressor



Overview electrical devices on hull

1. bow thruster
2. 90Ah bow thruster-battery & main switch & 500A fuse
3. extractor hood
4. 220V socket
5. refrigerator / freezer
6. electr. bilge pumps
7. 90Ah engine-battery
8. 2A fuse voltmeter
9. 200A fuse to service-battery
10. main switch engine-battery
11. fuel sensor
12. engine room vent
13. heater
14. air condition
15. sea water pump AC
16. elect. toilet
17. boiler
18. Fluxgate-compass
19. shower pump
20. DC-panel
21. VHF
22. radio
23. heater control
24. inverter control
25. plotter
26. Powerboard
27. battery charger
28. inverter
29. AC-panel
30. main switch service-batteries
31. service-batteries
32. main fuses
33. relay charging current
34. log / echo sounder
35. fresh water pump
36. sensor fresh water
37. microwave
38. generator
39. wine cooler
40. TV
41. washing machine / dish washer
42. water maker
43. stern thruster
44. 90Ah stern thruster-battery & main switch & 500A fuse

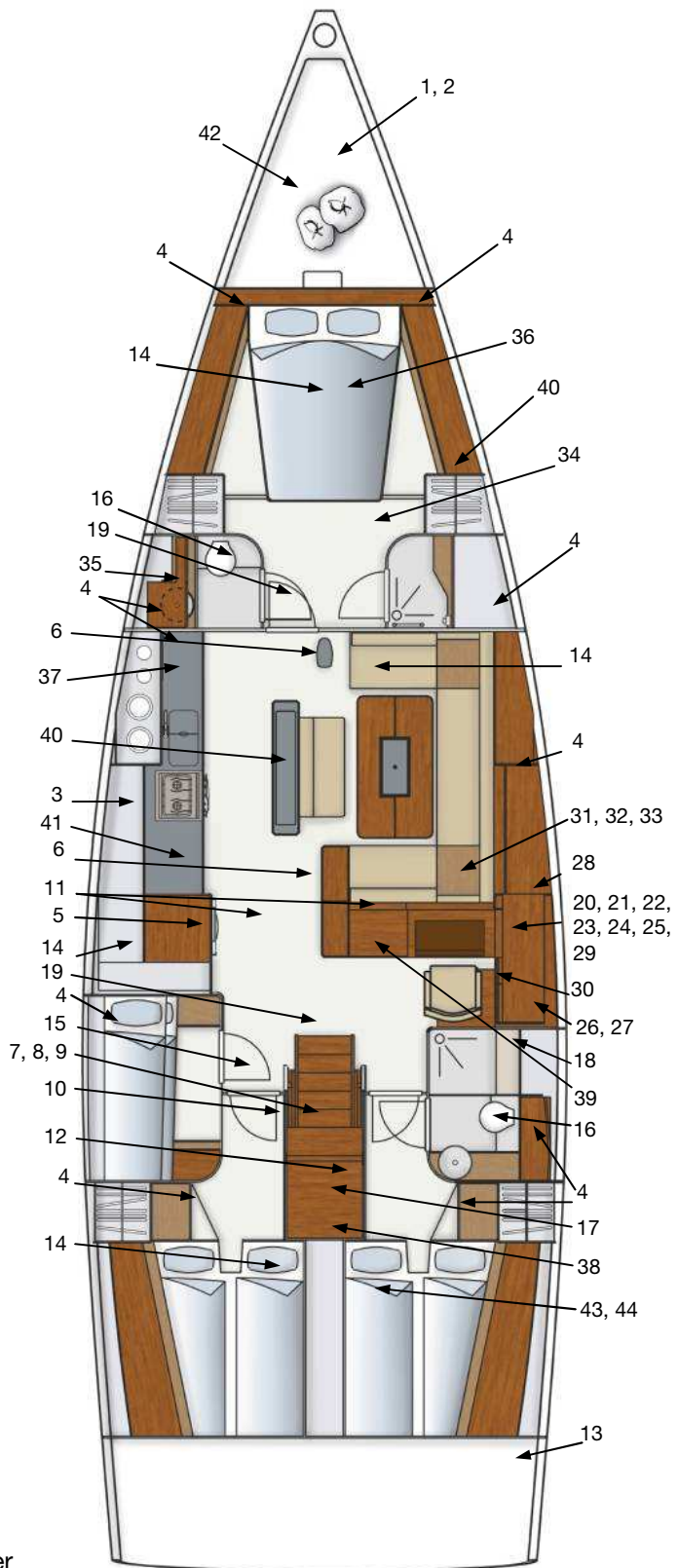

1.5.1. Direct current system

The direct current system is in charge of starting the engine and supplying power to the navigation instruments, the lighting and part of the electrical equipment on board.

Use the 220 Volt system when connected to shore power.

The power is distributed via the switchboard in the saloon. The circuits have switches so that the consumers can be switched on and off centrally. All power circuits within the system must be protected against overload by fuses. The fuses indicate whether there is a failure in the system. The circuit diagram can be made available by your dealer if required.



Interior lights	Tricolor
Navigation lights	Deck wash pump
Anchor light	Bilge pump with hose
Steaming lights	Stern door control
Refrigerator / freezer	Main furler system
Freshwater pump	Dinghywinch
Bilge pump – manual override	Reserve
Navigation electronics	Black water pump
Anchor winch	
Winch control	

Bild 10 DC-Panell

Pay attention because the battery capacity is restricted. If the voltage is less than 10.5 Volt a recharging of the batteries is necessary.

The essential circuits of the direct current consumers are:

- navigation lights
- interior and deck lighting
- electrical devices
- 220 V devices via inverters (according to the contract specification)

The interior and deck lighting consists of energy-saving halogen or fluorescent lamps and requires relatively little power. The navigation electronics also require very little power. Nevertheless, you should turn off the consumers you no longer need as soon as possible. This can also be done centrally from the main control panel.

Is it not possible to recharge the batteries you must reduce the power consumption by switching off of not necessary consumers. Nautical lighting has absolute priority. In case a capacity bottleneck occurs due to a failure in the supply, all other consumers must be switched off first.

We recommend you to switch on the consumers according to their importance:

- By night only the navigation lights;
- Lighting of the chart table only if used;
- Navigation instruments, if necessary switch to ‚stand by‘;
- VHF radio station only in critical situations.



Note

If an autopilot is installed, it can consume a lot of power, especially when sailing in heavy swell, because the electric drive may have to carry out significant steering corrections depending on the swell conditions.

The general lighting should also only be switched on when necessary. One should dispense with the refrigerator box, the heating and other consumers that require a great amount of energy.

Remember to recharge the batteries when at sea, as well. Start the engine while sailing can recharge the batteries up to the desired state so that the next most important consumers can be switched on.

In case of malfunctions, you should check the electrical systems and installations to find out the reason for insufficient charging.

ENGINE BATTERY

The engine battery is used to start the engine and is located in the engine room.

BATTERY MAIN SWITCH

The engine battery switch is in the port aft cabin and the service batteries switches are in the saloon on the starboard side on the seat bench.

MAINTENANCE

The AGM batteries require low maintenance and should be well charged at all times. Please check this regularly.

In the winter season it is necessary to store the well-charged batteries in a dry and frost-free place. Take care that the poles are clean and protected against corrosion with pole grease.

1.5.2. Alternating current system

The 230 V installation on board is supplied with current via the shore connection or the batteries via an inverter (option) or generator (option).

In case there is no shore connection at your disposal, you should use the 230 V devices via the inverter in a very energy-conscious way, because the capacity of the batteries is limited. You may have to start the engine or generator to recharge the consumer batteries. Therefore: Use the 230 Volt system when connected to shore power.

The current is distributed via the switchboard in the saloon. The circuits are provided with switches so that the consumers can be switched from a central location. Fuses protect all electrical circuits within the system against overload. The fuses indicate whether there is a failure in the system. If required, your dealer can provide the circuit diagram.

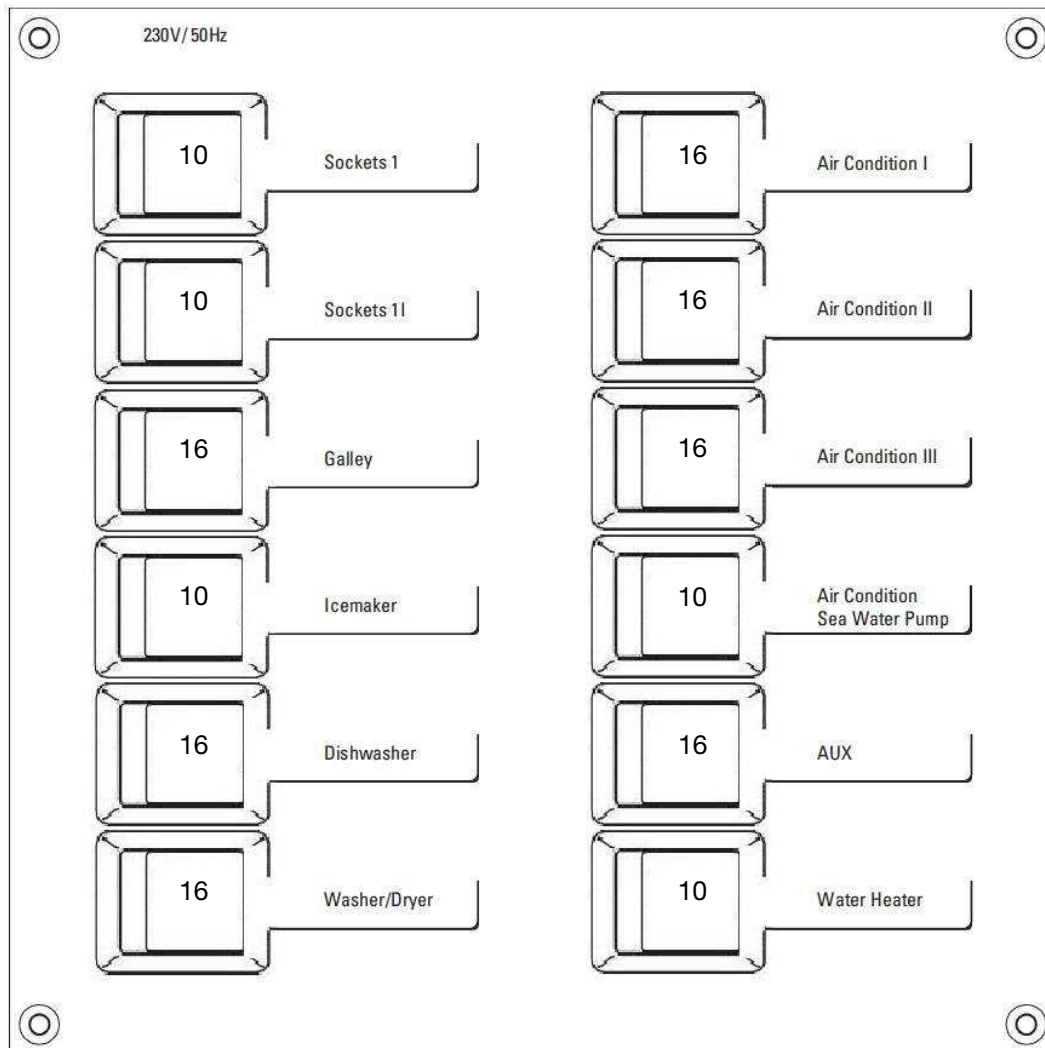

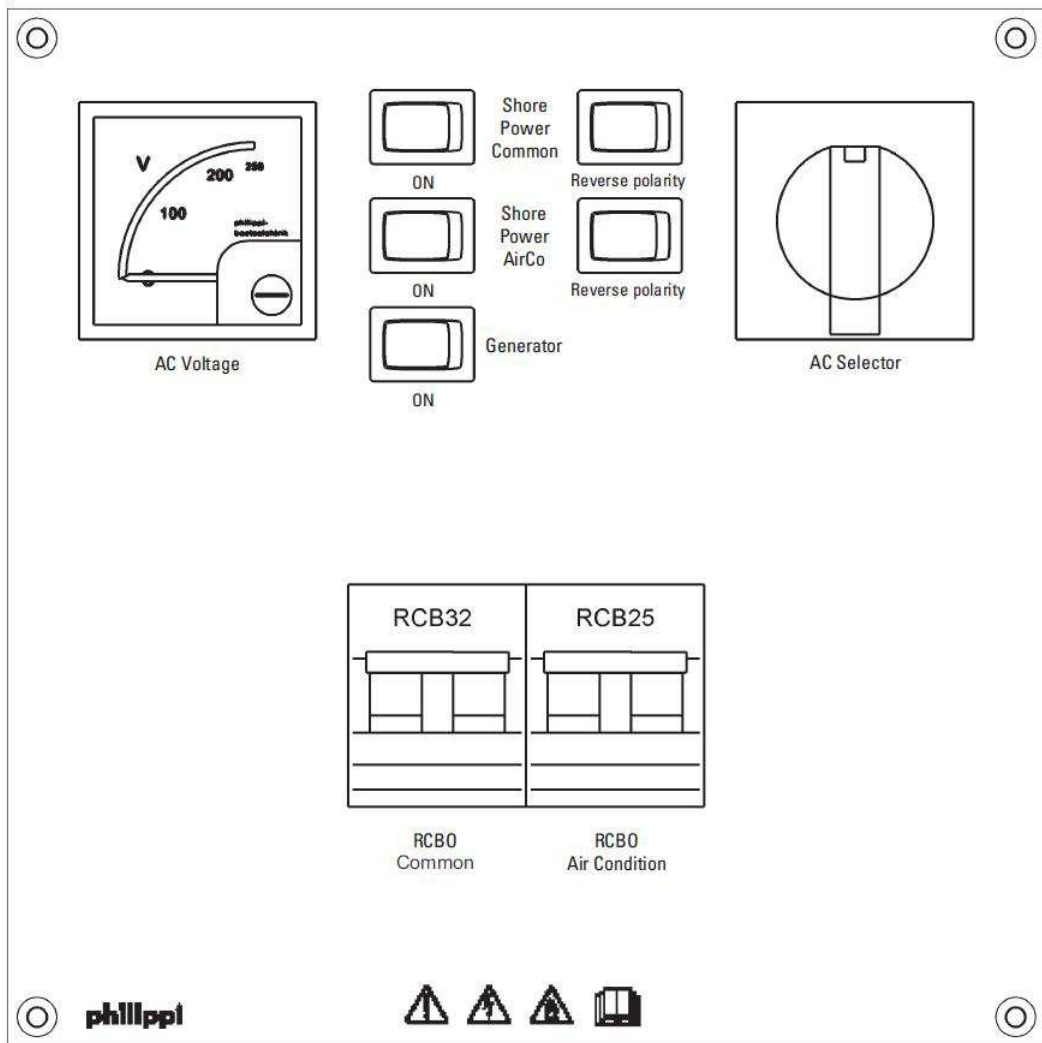

SHORE CONNECTION

If the yacht is equipped with a shore connection socket, you have 230 V at your disposal. With the appropriate shore-connecting line you can ensure power supply in a way that spares the batteries.

The shore connection socket is protected by a fuse. The connection is established by means of a compatible shore-connecting line.

Please consider that on the shore there is usually a limitation of connecting power so that this shore current cannot be used for heating.



Attention

Plug the shore connection cable first aboard and then ashore. Terminate the connection first ashore and then aboard

Pay attention that the shore cable and the connectors have no contact to the water. The connectors shall be water protected or watertight (rain water).

For your safety the shore power is protected with a GFCI device that is switching off the system immediately at a malfunction.



Note

This functionality of the switch must be tested regularly by pressing the release button or with the help of an electric tester.

BATTERY CHARGERS

The batteries can be charged with the installed chargers while the shore power is available. Make no changes at the charger installation without consultation by the yard. The batteries can be damaged. Take note of the operating instructions of the battery charger.

SOCKETS

On board there are sockets for 220 V alternating current at several places.

1.5.3. Navigation systems

Some navigation devices will be installed optionally. The main switchboard is prepared for additional installations.

All navigation lights are in a fixed position. They include the side, stern, top and anchor lights.

Make sure that spare bulbs are aboard.



Attention

All navigation aids and instruments (Plotter, Radar, Autopilot, AIS,...) are only intended to be supplementary and don't guarantee safety at sea.

The owner has sole responsibility for the correct use of the navigation aids and instruments, to avoid the risk of injury or damage.

The owner has sole responsibility for the safe operation of the yacht.

1.6. Anchoring, towing and mooring equipment

1.6.1. General

The boat owner/skipper is responsible for ensuring that the mooring lines, towing lines, anchor chains and anchors are sufficient for the intended service area. Boat owner/operator should consider too which measures are necessary in order to use a tow-line on board.

The strength of the used tow-lines shall not greater than 80% of the strength of the cleats.

1.6.2. Anchoring

The 25kg bow anchor is located ready to be dropped on the bow roller.

The chain falls in a chain locker. This is where the end is fastened.



Attention

Please pay attention that the holding of the anchors is perhaps restricted due to the sea bed (stony), to stormy weather, high waves, etc. Please take precautions to increase the holding power or to leave the anchorage.



Note

Washdown the windlass and anchor chain regularly with fresh water.

When hauling in the anchor, check the chain for debris as it can block the windlass.

Make sure that the anchor chain can run freely in the locker.

1.6.3. Towing

The anchor line can be used for towing. However, a special towing line of the same strength is more suitable. Fasten the towing line in the shape of a bridle to the two bow cleats. In case of longer towing distances wind a rope of the same strength around the entire boat in order to distribute the towing forces. Other points, e.g. the guardrail or the mast step, are not suited for towing. A towing line may only be attached in such a way that it can be slipped under load. Abrasions must be avoided!



Please note that, when towing, the speed of both the towing and the towed vessel must be below the so-called hull speed, otherwise the towing forces can damage the boat. This boat's hull speed is approx. 9.4 knots (=17.4 km/h).

Depending on the weather conditions, swell and depth of the water, it could be necessary to reduce this speed considerably, since the occurring loads can lead to damages.

1.6.4. Mooring

The cleats arranged on the bow and stern with a breaking load from 4000 daN, which are sufficiently dimensioned to deal with the normal forces in protected ports, are used for mooring.



Use the onboard winches or cleats in pairs to position the boat.

In case the boat is unattended for a longer period of time, protect the mooring lines against wearing through and unintentional detachment.



Before starting a voyage, the skipper must make sure that

- the anchor and the chain are clear;
- the necessary docking and towing lines are on board and in working order.



Only use the cleats and winches to moor the boat. The guardrail and other points on deck are not suitable.

1.7. Engine system

1.7.1. Structure of the engine room

The centrally arranged main engine on a stable mount takes up most of the space. It is elastically bedded so as to absorb vibrations and sound. The area underneath the machines is shaped like an oil tray that must be cleaned regularly. Due to the light colour, you can immediately see whether there are leaks in the oil circulation. The area below the engines should be checked periodically to detect oil leaks in due time. This area must always be kept clean.

All hull openings are equipped with seacocks. Before travelling, check whether they are open and whether the seawater filters are dirty.



Observe the operating instructions of the engine system and the notes on operation, maintenance and care therein.

Include the opening for the shafting in your regular inspections.

The exact description of the drive line is in the operating instruction for the engine.

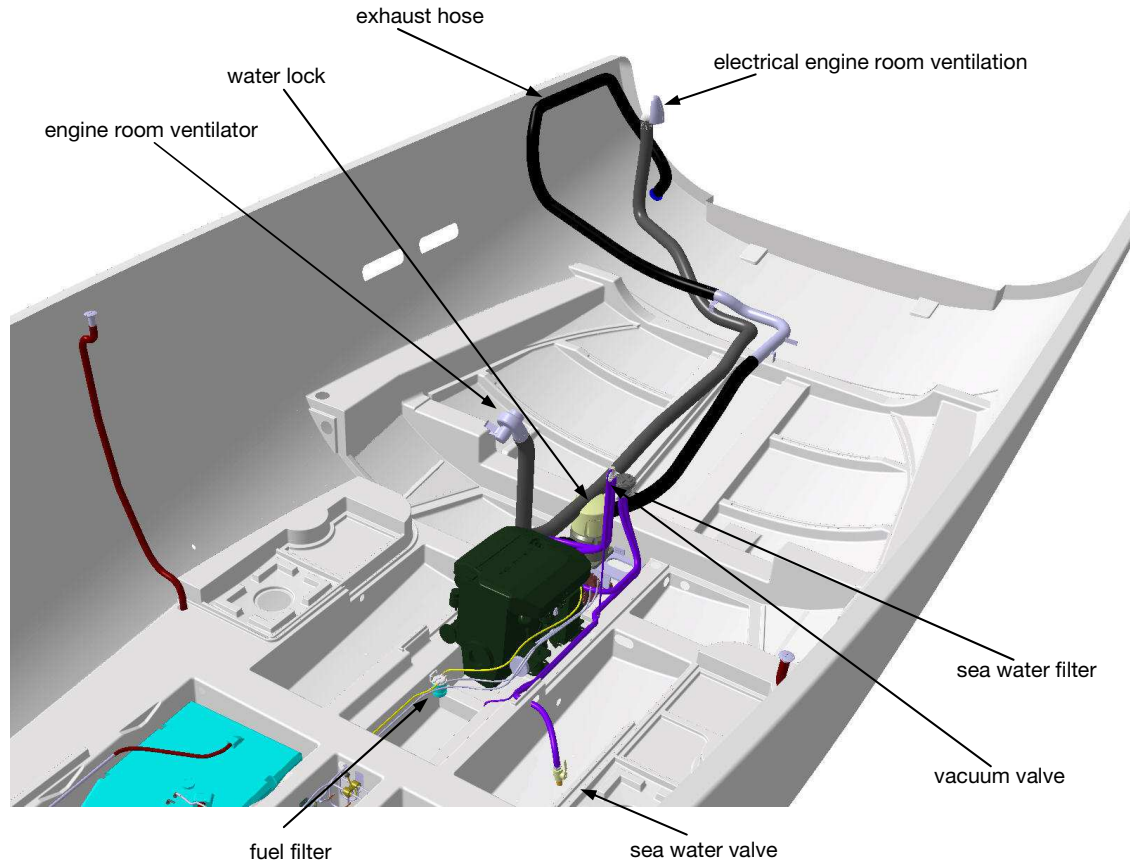

1.7.2. General

The boat may be operated with a maximum engine performance of 1 x 110 kW. Changes to the concept must always be implemented in agreement with the yard. The shipyard cannot take on liability for changes to the concept that were not agreed upon with the shipyard.

The speed must be reduced on crowded, much used waterways or in case of poor visibility. Reduce the speed and keep a lookout for reasons of courteousness and your own and other people's safety. Observe the speed limits and the notices to avoid swell.

Observe the right of way as it is demanded by the rules for waterways (COLREGS).

Always keep a sufficient distance so that you can stop or manoeuvre to avoid collisions.

1.7.3. Instruments

HELM POSITION

Rev counter

This instrument shows engine speed in revolution per minute. Cruising r.p.m. varies with conditions and type of fitted engine.

Alarm systems

The acoustic alarm is released if the main engine cooling water temperature exceeds the allowable limit or the oil pressure is too low.

The oil pressure alarm is also activated if the ignition is switched on but the engine is not running.



If the alarm is activated whilst the engine is running, the engine should be down immediately and the reason of the alarm should be investigated.



The engine should be warmed up slowly and not accelerated to full speed if the operating temperature has not yet been reached.

1.7.4. Cooling system

The engine is equipped with a two-circuit cooling system.

The internal system is a closed circuit. In case of frost, an antifreeze agent must be added to the internal circuit. The temperature is controlled by a thermostat. During winter storage, the cooling water needn't be drained off if it is mixed with an antifreeze agent suited for the existing temperatures below freezing.

The external circulation draws seawater through the seacock under the floor board in the saloon next to the companionway on the port side. After passing the heat exchanger the cooling water is injected into the exhaust system in the exhaust elbow. Together with the exhaust gas the cooling sea water is exhausted via the silencer and the exhaust pipe at the stern. This guarantees a trouble-free engine operation. Moreover the engine noise is reduced..

The heat exchanger serves to cool the engine oil, the cooling water of the primary circulation and the hydraulic oil of the gears.

The seawater filter must be cleansed regularly.



Check the seawater filter regularly. Depending on the water quality, cleansing may be necessary.



After starting the engine, check whether water is discharged from the exhaust, also intermittently, in addition to the exhaust gas.

In addition, the cooling water supply must be checked and ensured.

Before starting the engine:

- make sure that the cooling water inlet is open,
- make sure that the engine room is ventilated,
- take a look into the engine room to check for possible leaks,
- keep the engine room hatch closed (danger by exposed parts).

When the engine is running:

- visually check whether cooling water comes out of the exhaust.

A temperature sensor indicates optical and acoustical if the cooling temperature is rising about the maximum permitted value. In this case stop the engine and check the cooling circulations!

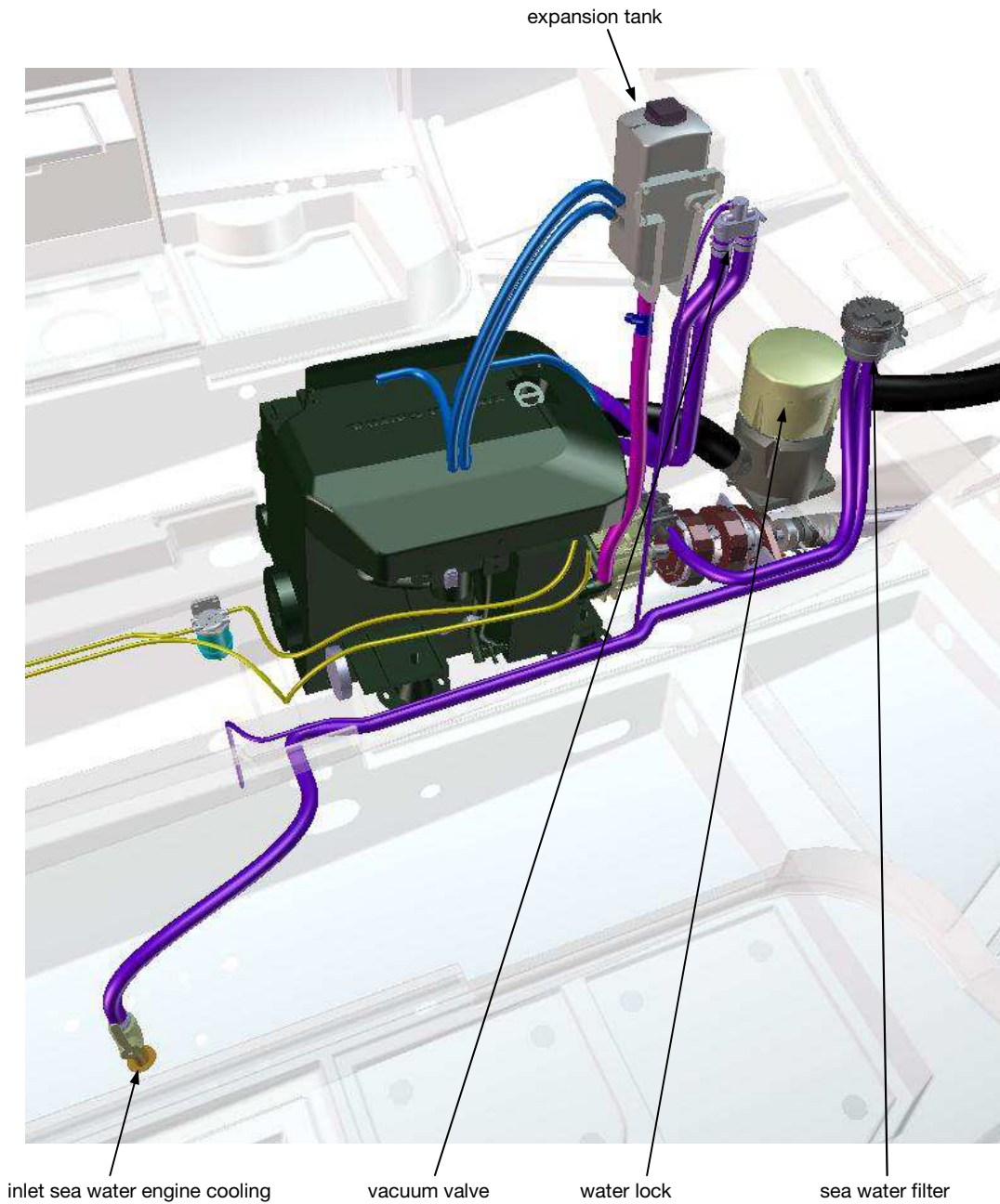

If the engine does not start after the third attempt, please shut the seawater valve for cooling the engine. Try to start the engine again. If the engine starts, open the seawater valve again (within half a minute).

1.7.5. Exhaust system

The exhaust is discharged at the stern, thus reducing the sound emission. The exhaust system consists of high temperature resistance hoses and pipes with silencer/water lock. The exhaust installation is included in the seawater cooling systems. Arranged in this manner, the exhaust system meets the requirements of the directive 2003/44/EC annex I.C.

Beneath the elbow the water is led to the exhaust installation and discharged to the outside along with the exhaust gases. It cools the exhaust and reduces the noise.

It is very important that the cooling system is running. As already mentioned in section 'Cooling system', is to be checked, whether water is discharged from the exhaust pipe while the engine is running. The exhaust gas should neither be sooty nor blue. If this is the case, either the engine's air filter must be cleaned – which you can do yourself – or a specialist workshop has to adjust the engine.

For safety reasons, the hose connections on the suction side are equipped with double hose clamps.

If the boat is not in use, close the seacocks and drain the water out of the exhaust duct.

Notes on winter storage

Freshwater and seawater circuits are to be emptied according to the detailed instructions in the engine's maintenance guide, and the conduits are to be ventilated.

1.7.6. Lubrication

The engine is lubricated according to the specifications in the operating instructions of the engine and other installations.

Please note that during oil change the oil must be sucked out with a pump. When changing the filter you should use an oil absorbing cloth against dirt.

The oil must be changed at least once a year even if the boat has used very little.

A well maintained boat should never leak. All the same, the engine's mount is shaped in the form of an oil sump, so that not even the smallest amount of oil can enter the bilge and thus the pumped out bilge water. In case water that is possibly mixed with traces of oil collects there, it must be filled into a separate canister by means of a small draining pump and disposed of together with the used oil.

1.7.7. Gearing

The gearing is a hydraulic gearing. With it can be changed the running direction. It is mounted directly onto the engine. Please read the special operating guide and the maintenance instructions of the gearing.

The gear was designed in order to withstand the stress during normal service. Avoid abrupt switching processes.

1.7.8. Gear shift

The engine's speed and the gearing are controlled via electrical gear. (see 1.7.7).

1.7.9. Shafting

The sailing yacht has customary shafting. On the gearing is mounted a maintenance free, highly flexible universal Centaflex joint shaft.

The lead through at the stern post is sealed with a PSS Packless Shaft Seal

The PSS packless shaft seal is water cooled and don't need grease and are maintenance free.

As with any rubber hose, the PSS bellows must be inspected on a regular basis for any sign of wear, aging or chemical deterioration.

The PSS bellow should be replaced in six year intervals.

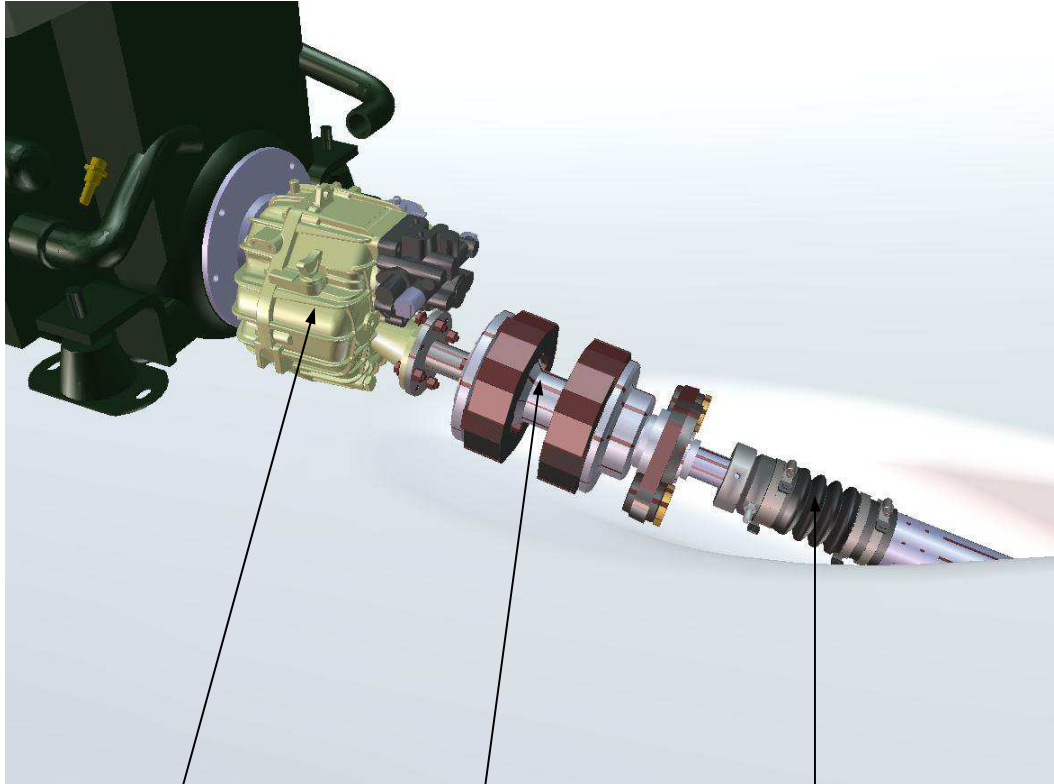

gearing

Centaflex Kupplung

PSS Packless Shaft Seal



Attention

Also check the tightness of the shaft seal during your inspections.



Attention

Avoid contact with the seabed because this could damage the propeller or the shaft.



Note

Check all underwater components of the shafting when preparing for winter storage and remove mussels and other marine foulings from the bearings.



Note

Pay attention to flotsam in the water. Lines and plastic bags which come into the bearing can damage the bearing and the shaft and reduce the life time.

1.7.10. Propeller

The propeller is calculated according to the performance and designed speed. Watch out for unusual vibrations in the area of the propeller that could be caused by damages to the propeller.

Notes regarding winter storage

For winter storage, the propeller should be cleaned of possible incrustation of foreign matter, inspected and the flapping mechanism greased. In case of deformations, dents or nicks, the propeller must be repaired and balanced by a specialist.

1.8. Ventilation

Ventilation can take place via the existing hatch openings and inlets. The engine room is electrically ventilated. The air circulation must not be obstructed and the ventilation system may not be altered.

Good ventilation prevents corrosion, marks caused by damp or mildew. This applies to both summer and winter. The low humidity in winter during clear weather lets the boat dry well.



Note

Ventilate the boat as often and as well as possible for the sake of the boat and your own wellbeing. Humidity and changes in temperature can lead to the precipitation of moisture.

If the boat is not in use for a long period of time stand the cushions upright. Air the cushions regularly in the sun.

Defrost the fridge / freezer regularly. If the boat is not in use for a long period of time, open the doors of the refrigerator / freezer to prevent mold growth.

Carbon monoxide can accumulate in closed cabins or cockpits. Carbon monoxide can be created by

- emissions from the running engine;
- at low speed, wind from astern or while the boat is moored;
- or from neighbouring boats.



Danger

Carbon monoxide is an odourless, invisible and extremely poisonous gas. Inhaling carbon monoxide can result in injuries or death.

Ensure adequate ventilation!

1.9. Heating⁵

If your yacht is equipped with heating (option), please read the operating instructions.



Note

Observe the operating instructions of the heating system and the notes on operation, maintenance and care therein.

The optional heating consists of 2 heating circuits, a small and a large heating circuit.

When the small heating circuit is switched on only the water in the boiler is heated.

With the optional heating the boiler is not installed on the heat exchanger of the engine!

By switching the control in the navigation area on the large heating circuit. The heating unit is switched on, this provides heat to the radiators and the boiler.

The control of each radiator fan is done separately by the individual operating units in the cabins.

⁵ According to contract specification

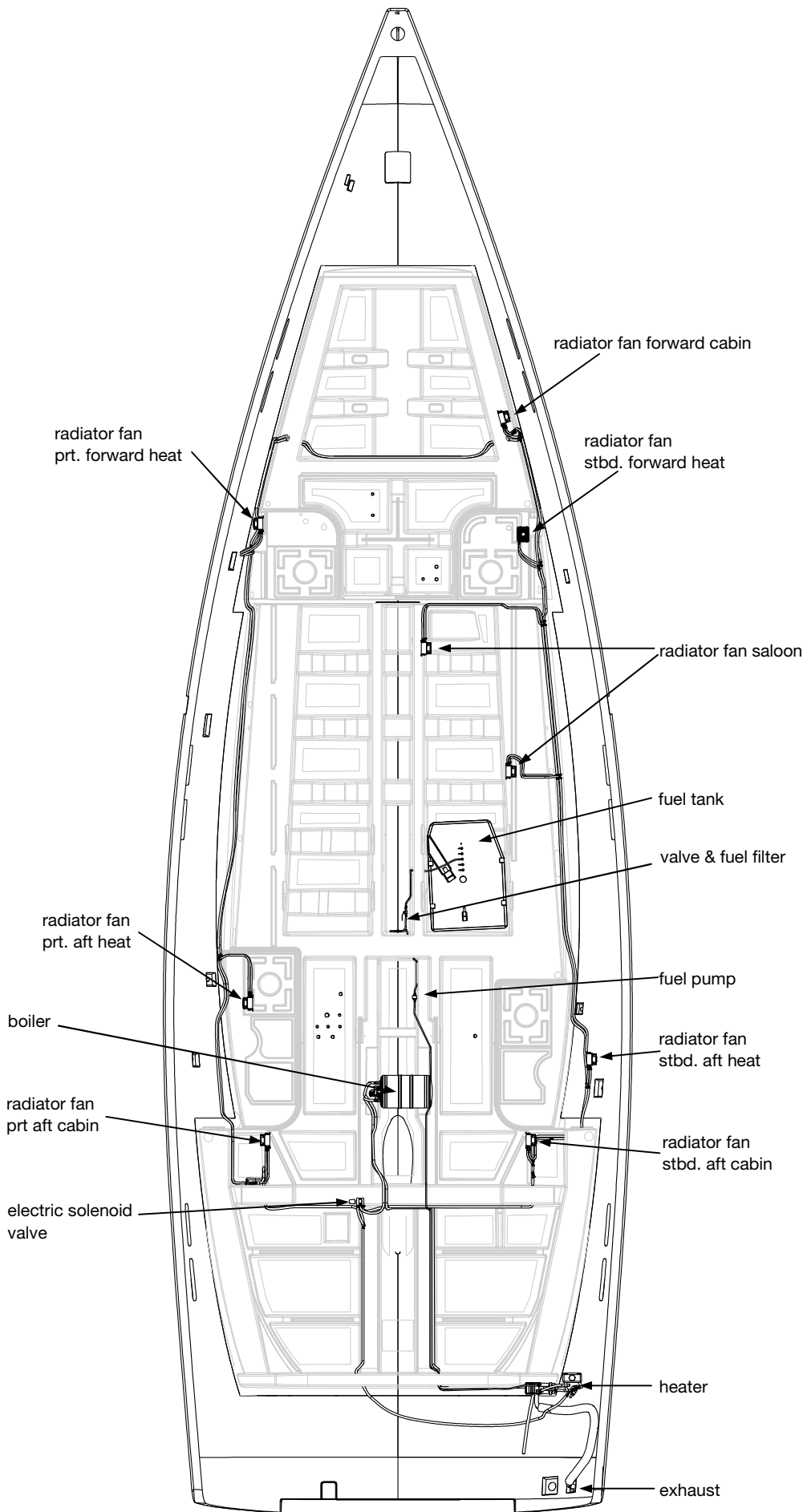

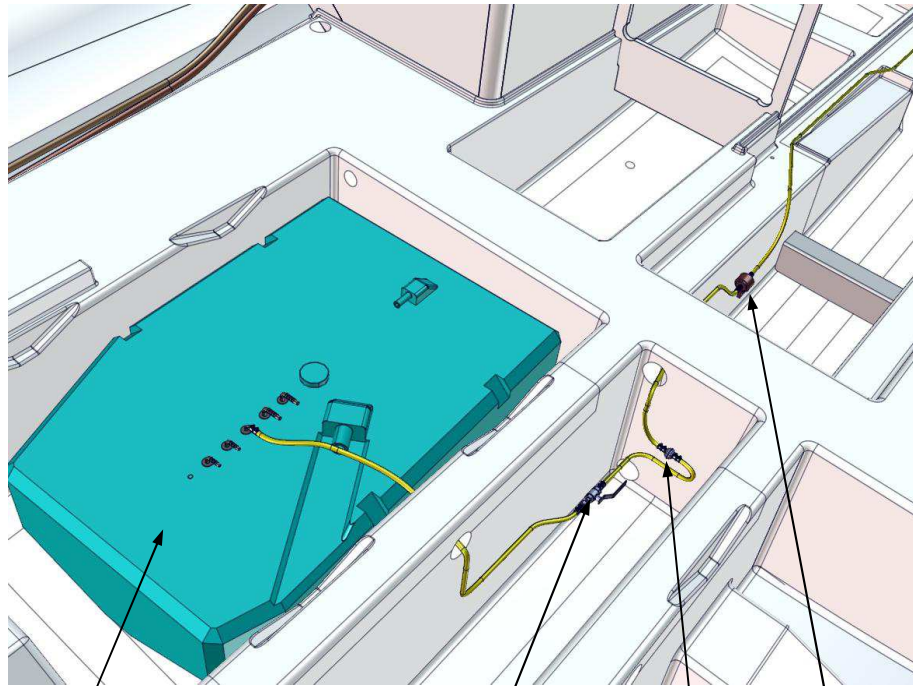

fuel tank

valve

strainer

fuel pump

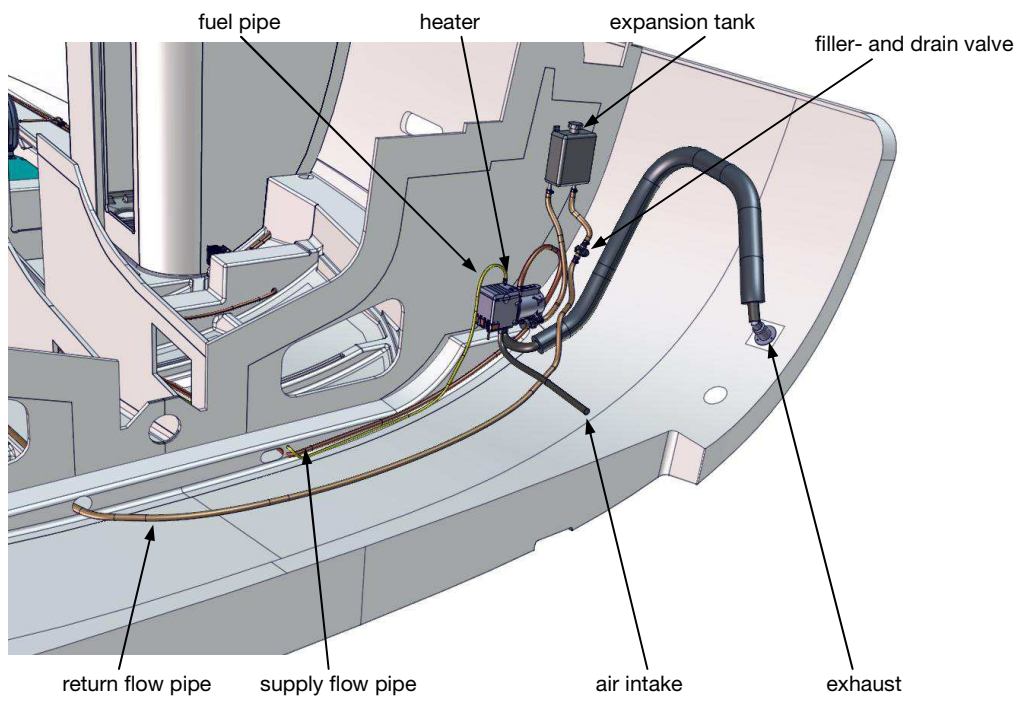

fuel pipe

heater

expansion tank

filler- and drain valve

return flow pipe

supply flow pipe

air intake

exhaust



Attention

Do not obstruct or close the openings. Otherwise there is a risk of fire.

1.10. Air condition

If your yacht is equipped with air condition (option), please read the operating instructions.

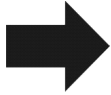

Note

Observe the operating instructions of the air condition system and the notes on operation, maintenance and care therein.

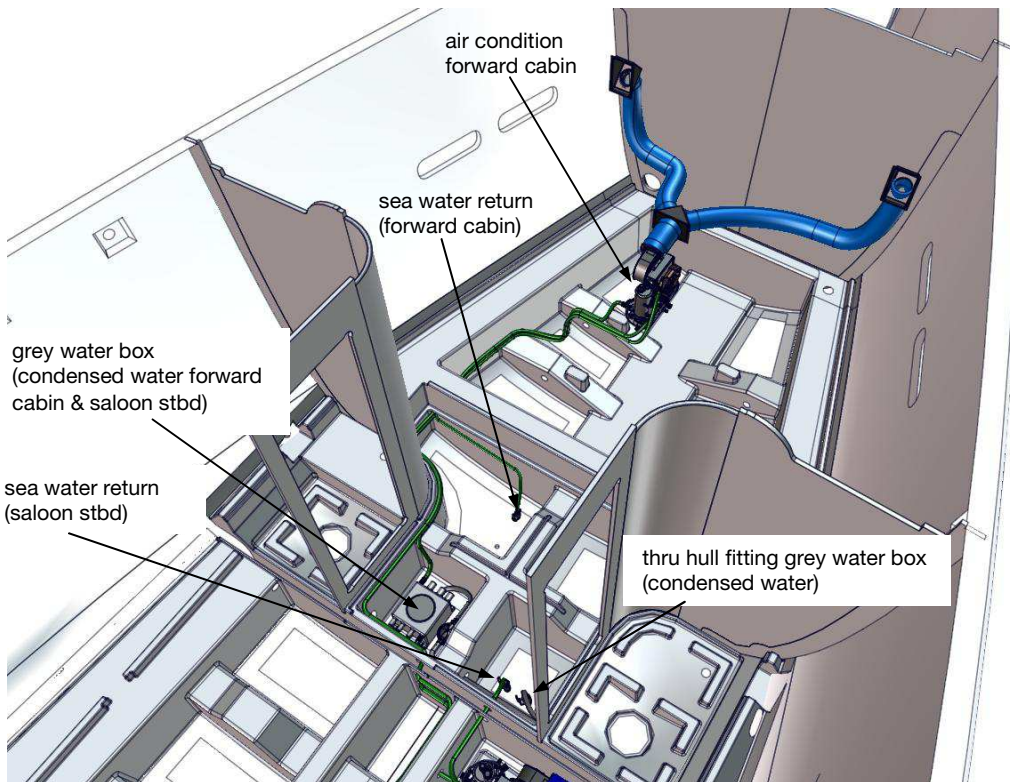
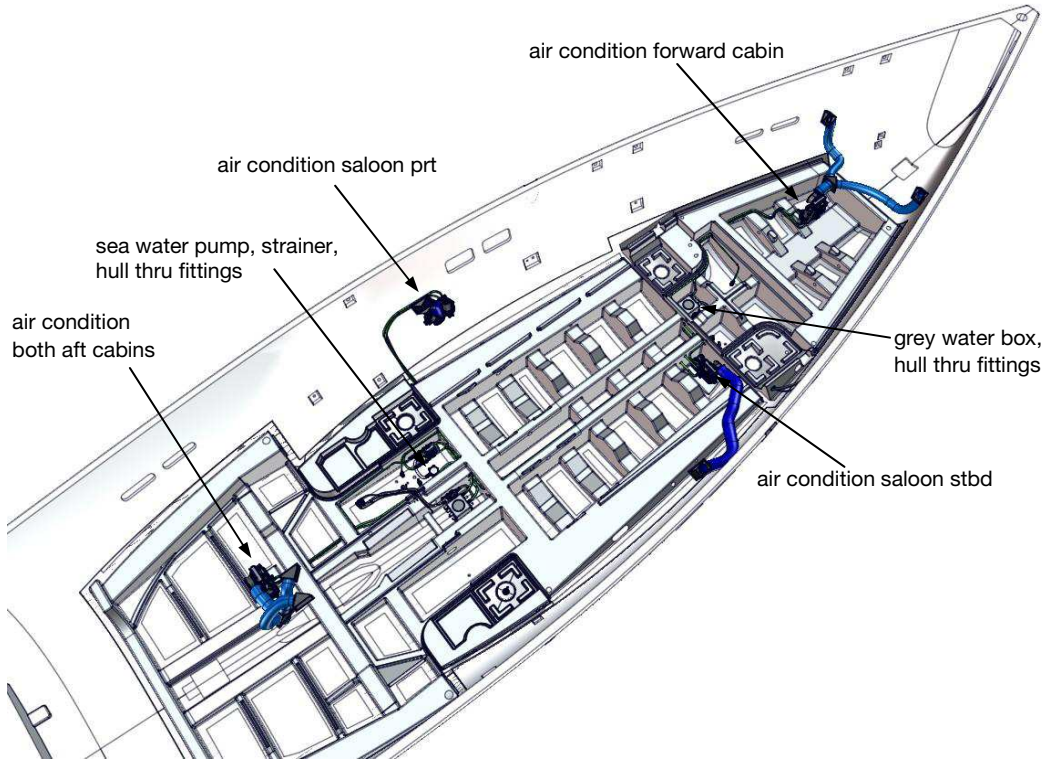

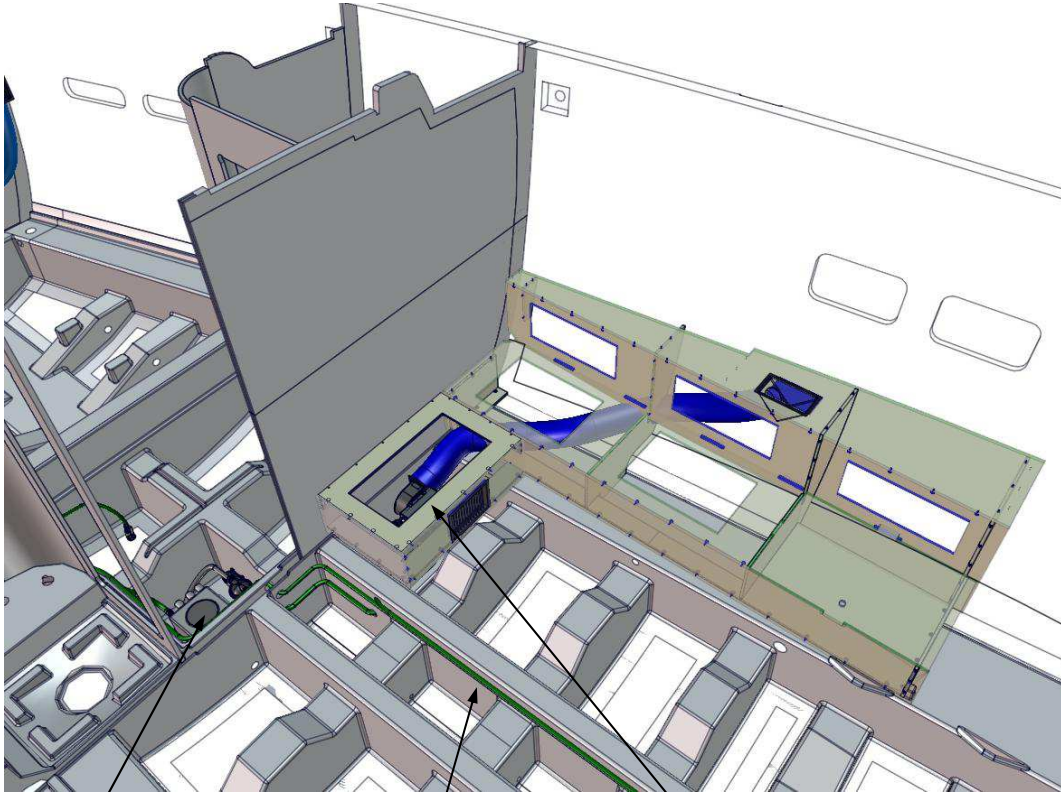

grey water box (condensed water forward cabin & saloon stbd) sea water supply air condition saloon stbd

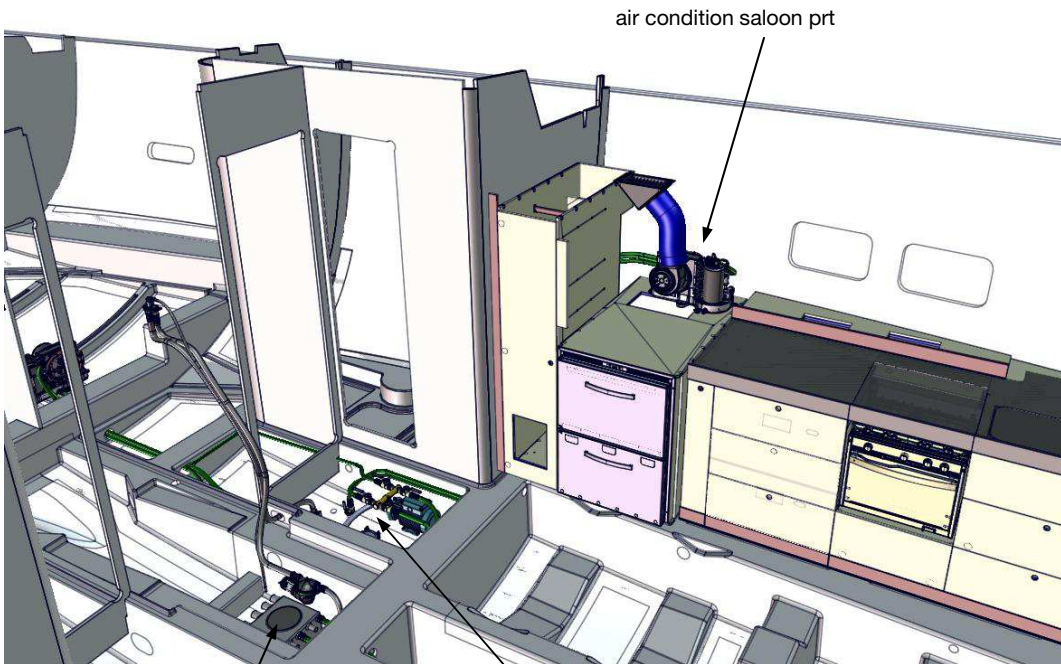

grey water box (condensed water saloon prt & aft cabin) sea water pump, strainer, hull thru fittings

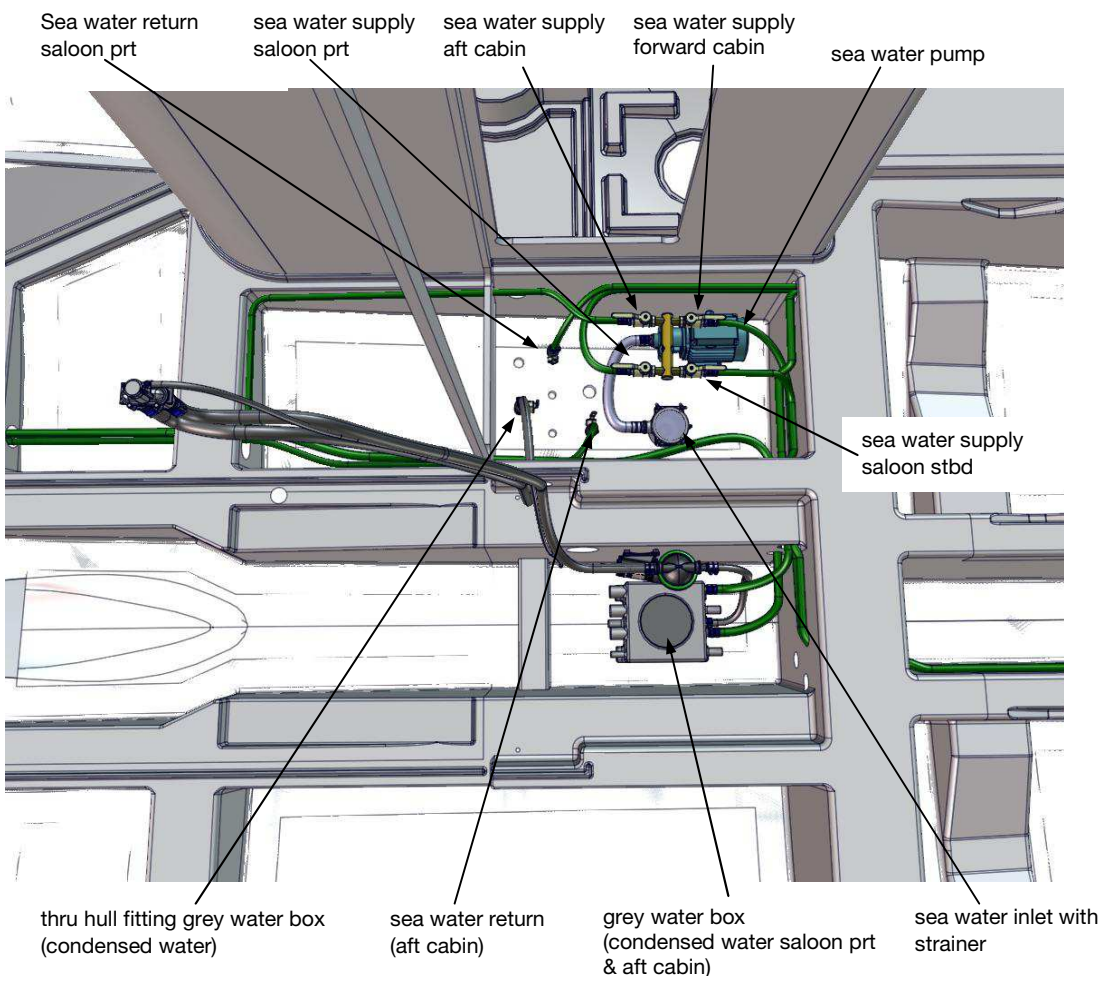
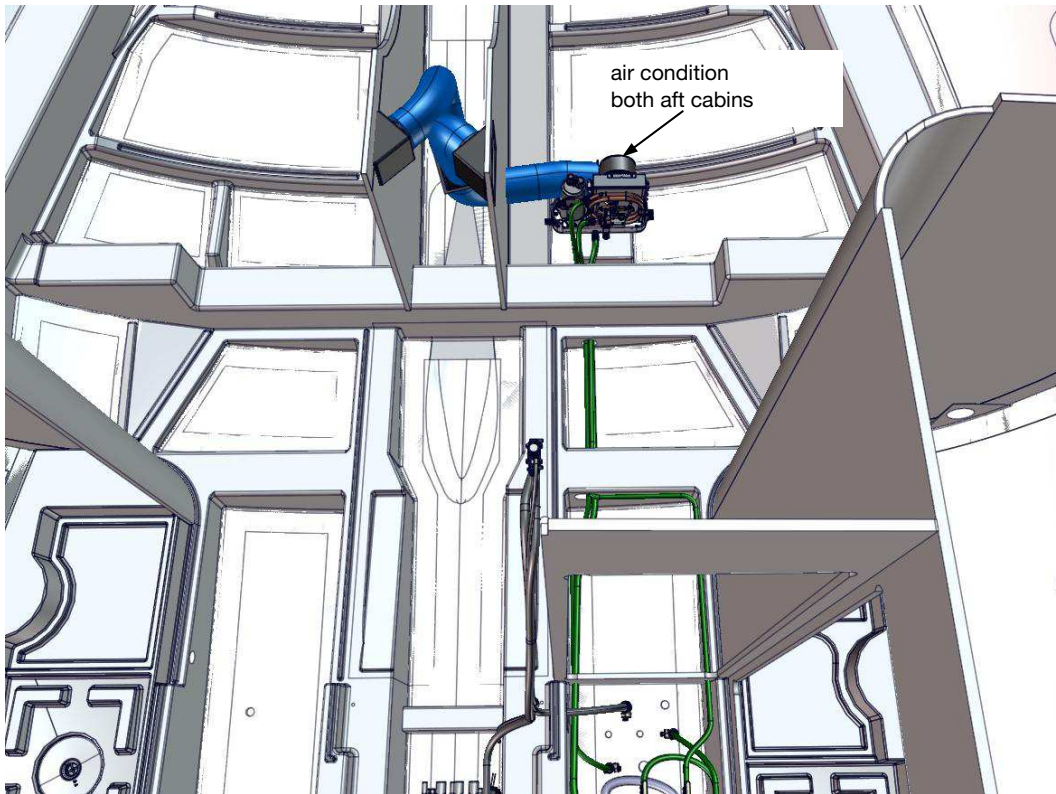

1.11. Generator⁶

If your yacht is equipped with generator (option), please read the operating instructions.



Note

Observe the operating instructions of the generator system and the notes on operation, maintenance and care therein.

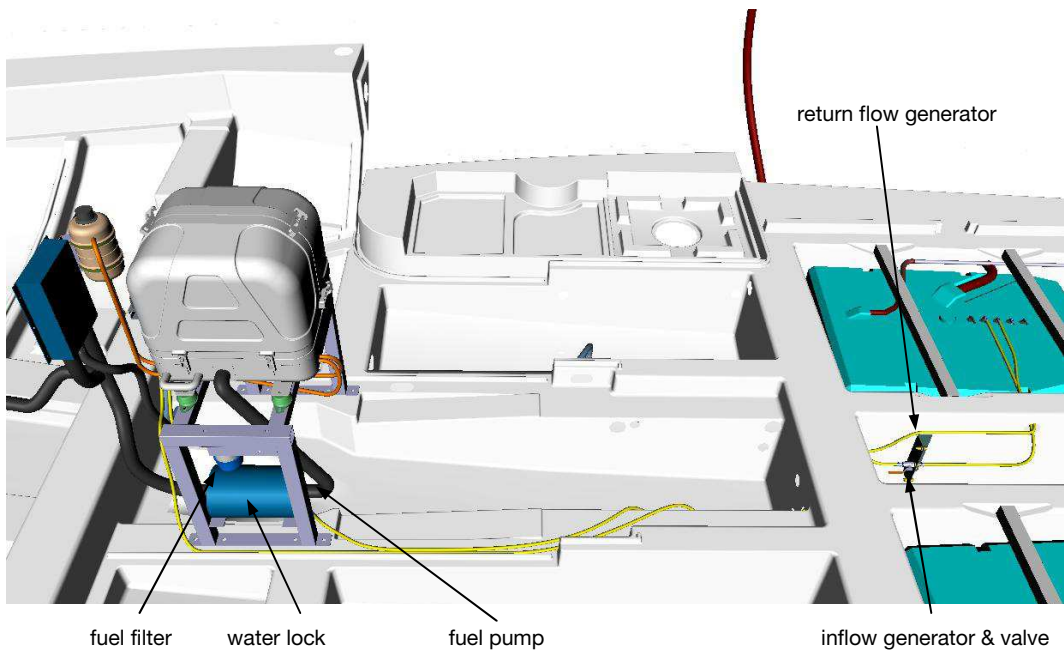
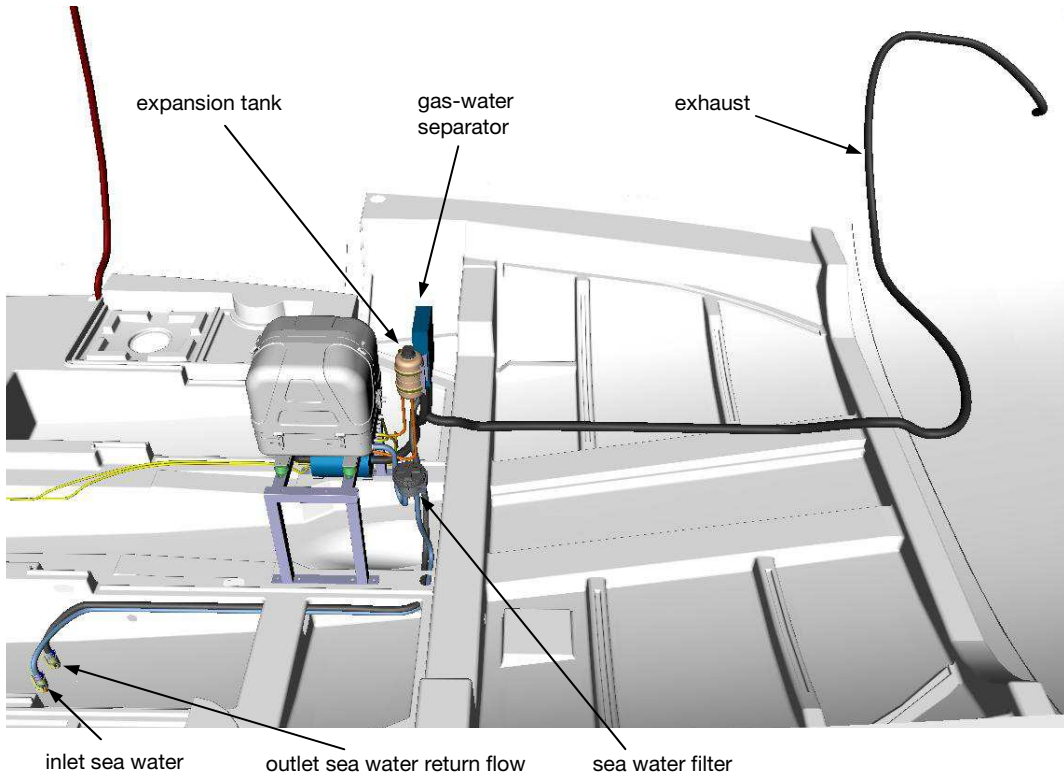

⁶ According to contract specification

1.12. Bow thruster / Stern thruster⁷

If your yacht is equipped with bow and stern thrusters (option), please read the operating instructions.

The batteries, the main switch and the fuses are located next to bow thruster and stern thruster.

Do not leave any objects in the range of the bow and stern thrusters. Loose objects left near the electric motor may cause problems with electric lines and may even result in short circuit. Secure all pieces of equipment to prevent them from shifting!

Switch off the main switch on leaving the boat.



Note

Observe the operating instructions of the bow and stern thrusters and the notes on operation, maintenance and care therein.

1.13. Liquefied petroleum gas system

1.13.1. Installation

The gas cylinders are stored in the port side stowage box in the dinghy garage. Please pay attention the special regulations of the country under which flag you are sailing!



Warning

Never:

- Change the state of the cylinder box.
- Create openings to the inside of the boat from the cylinder box.
- Install electrical systems or conduits in the cylinder box.
- Use the cylinder box as a stowage space.

Any modifications to the concept of the LPG system may only be carried out by an expert for LPG systems on boats and by the shipyard.

The cylinder box is ventilated outboard. Possible water that has penetrated is drained through the opening.



Note

Keep the ventilation opening free of blockages. Check regularly the state of the opening!

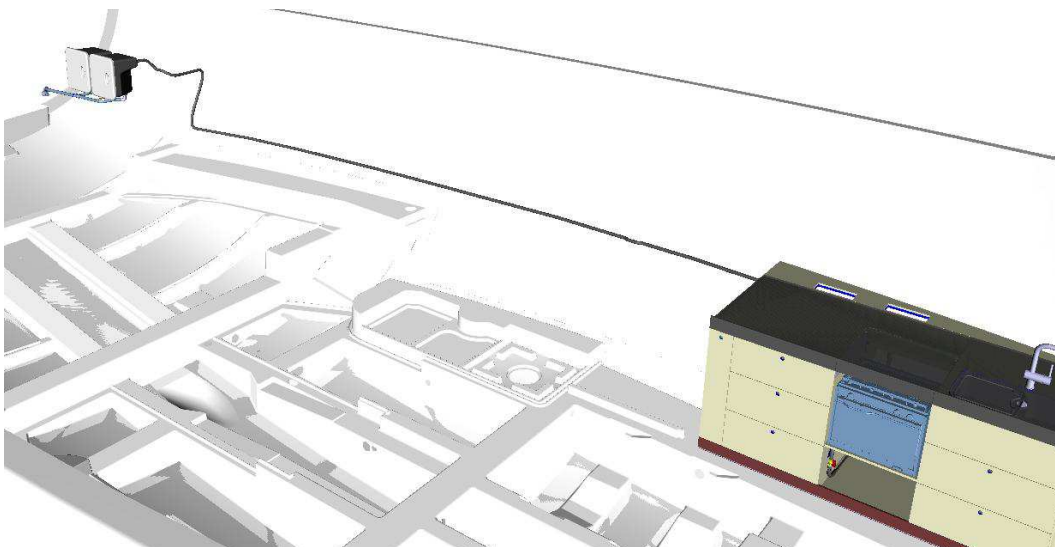

⁷ According to contract specification

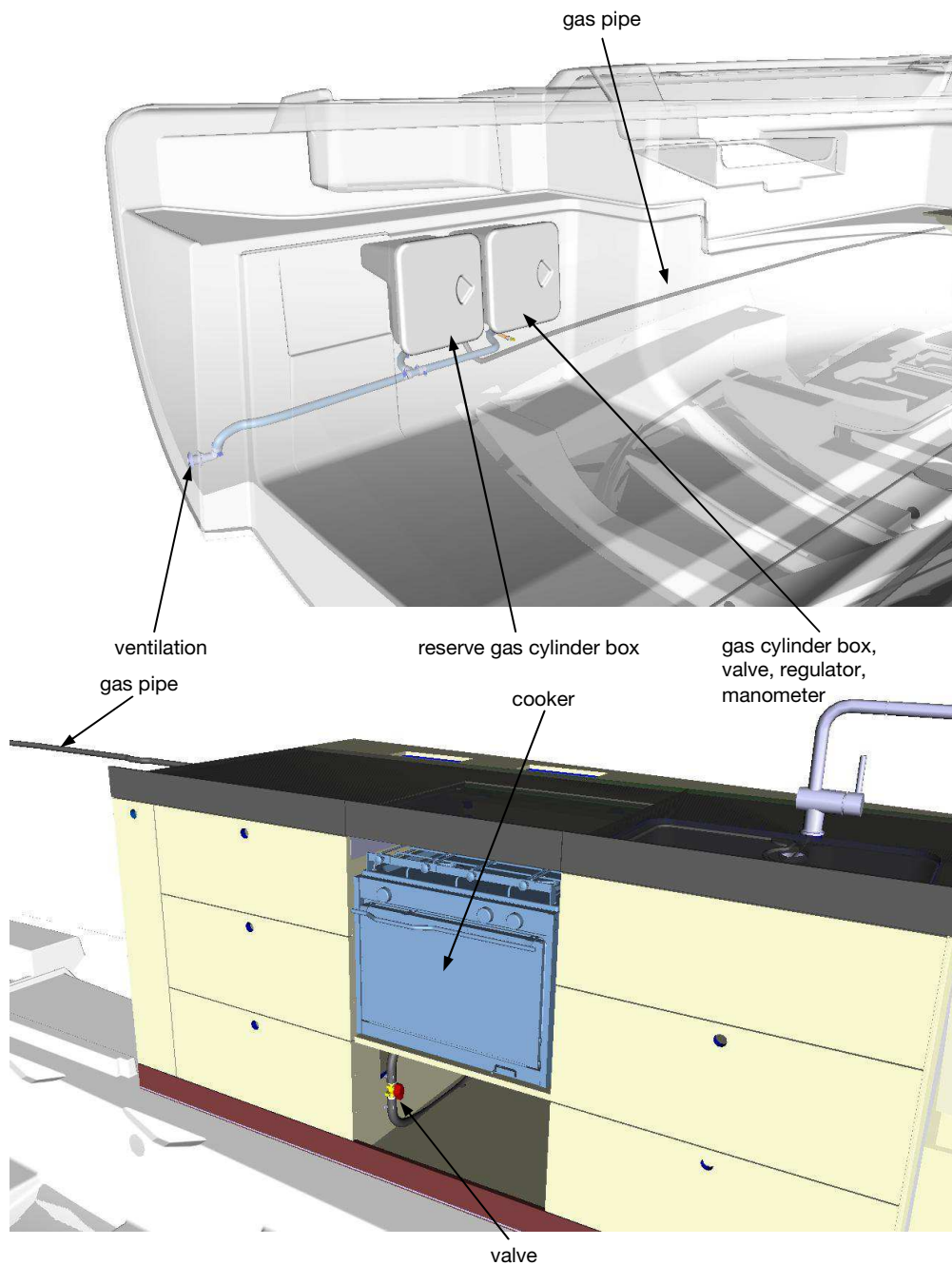

1.13.2. Replacement of the gas cylinder

Replace the gas cylinder as follows:

- First, switch off all gas consumers.
- Switch off the engine.



Never smoke or use open fire whilst replacing the cylinder.

- Shut-off the valve at the cylinder.
- Remove the pressure regulator at the valve of the cylinder. Only use appropriate tools so that you don't damage the connection and the fitting.
- Detach the empty cylinder from the mounting and take the cylinder from the cylinder box.

- Insert the new cylinder in the mounting.
- Fasten the mounting to the cylinder.
- Check if the connector thread at the cylinder is damaged.



Cylinders with damaged threads may not be used. There is a danger of leaking gas.

- Carefully place the union nut and screw it hand-tight.
- Screw the union nut tight with an appropriate tool.
- Check whether the connection is tight.



Never use grease at the cylinder connection or the valves.

1.13.3. Operating the gas system

Check the LPG unit for possible leakages before use:

- Shut the valves of the appliance
- Open the valve of the cylinder and wait for stabilisation from the pressure;
- Shut the valve of the cylinder;
- Watch on the manometer for 3 minutes; the pressure should remain constant!

The gas system must be operated with great care. You should therefore keep to the following sequence:

- Check if the cooker valve is shut.
- Open the valve in the cylinder box.
- Open the valve in front of the cooker. It is inside the cabinet under the cooker.
- Open one of the burner valves, keep it pressed (safety pilot) and ignite the gas.
- Keep the valve pressed until the flame burns stably!

When turning off, keep to the following sequence:

- Shut the valve at the cylinder; the flame extinguishes.
- Then shut the valve in front of the cooker and the burner valve!

1.14. Corrosion protection, painting system

Only high quality materials were used. They are largely non-corrosive.

The maritime climate is very aggressive. In result of this the forming of film of rust can appear, particularly in the vicinity of corrosive metal pieces. With suitable cleaning agent it is possible to remove the corrosion.

Please take care that the components and fittings made of aluminium alloys as well as corrosion-resistant and acid-resistant steels (stainless steel) are not permanently in contact with other metals.

The wooden parts do not require special protection. Section 4 describes how to care for them.

The hull below the waterline shall be protected with special painting to prevent the danger of marine fouling.

1.15. Manuals and operating instructions

Depending on the contract specifications, manuals, operating instructions etc. can be included.



Please read them carefully and take note of the guidelines and notes contained therein!

2. Starting up

2.1. General notes

Transport by water is more preferable than by land.

If the boat shall be transported ashore, a special vehicle must be used, because the dimensions are too large for a transport by rail or a normal vehicle. Pay attention that the vehicle is suitable for such transports.

Today it is normal for that boats with these dimensions will be lifted with cranes or other special lifting tackles, like as a Travellift. Possibly use a spreader beam so that the forces cannot press the yacht together (see also section 2.2).

But there is also the possibility of slipping, meaning that the boat is taken from the water by means of a cradle.

During all transport procedures, possible points of abrasion are to be protected.



Control the ships movements whilst hanging freely in the air by means of two lines, fixed at the bow and the stern each.

Never stay under pendulous loads!

After the boat is launched and rigged, it may be possible that the doors and drawers do not close perfectly and gaps are present. In this case simply re-adjust the hinges.

2.2. Attachment points for lifting gear, support points for slipping and transport

Craning

In many ports yachts are launched or put on ashore with cranes and hoisting gear. The belts must be attached in a way complying with the stability of the hull and the distribution of weights so that the boat is, as far as possible, in a horizontal position.

The boat may only be lifted with belts and a crosshead dimensioned for the load. The correct position of the belts should be marked with stickers below the toe rail.



The rear belt is in the area of the shaft. It may not be attached over the shaft or the propeller!

Slipping

If the yacht is transported to the shore on a slipway, it is recommended to use an appropriate cradle for transport and storage preventing the yacht from tipping over. The yacht may stand on its keel.

If the yacht is to stand on the keel over a longer time, forward and after quarters have to be supported efficiently in order to relieve the structure.

Storage

On principle, the yacht is only to be stored using an appropriate transport and storage cradle. A three-point bearing is permitted.

Regarding the excellent sail characteristics of our boats and the lightweight construction the supports must be arranged carefully. Pay attention that the hull will not be damaged. The supports should have an area of at least 200 mm by 300 mm and should be cushioned (but not too soft).

In principle it is to be considered that the boat is evenly supported. It must be ensured that the supports do not bear the full load. The keel must be supported separately and its weight is to be absorbed.

Transport

A land transport can only be carried out with a special-purpose vehicle.

The guidelines for transport are generally the same as for slipping and storage, too.

In addition, the yacht must be supported at forward and after quarters to relieve the structure. The yacht must be secured with at least 2 appropriate belts.

2.3. Underwater painting

If the boat has not been provided with an underwater painting by the shipyard or the trader, you should do so or have it done by a specialist firm before the first launch. It extends the durability of your boat and reduces the tractive resistance.

2.4. Engine, propeller

The boat is delivered with an installed drive system ready for operation. The negative terminals of the batteries have to be connected and to open the valves of the fuel tanks before driving. Make sure that there is fuel in the tank.

You may only start the engine when the boat is in the water and the seacock is open. Start the engine according to the operating instructions of the drive system.

Check if cooling water is discharged from the exhaust after the engine is started.

To run in the engine, follow the operating instructions. Do not run the engine with too many revs and keep to the oil change intervals.

2.5. Equipment

The boat is equipped with a number of basic equipment. Generally it is necessary to complete the equipment in dependency of the service area.

Check the equipment to operability.

2.6. First voyage

Before starting a "grand voyage", make yourself familiar with all instruments and devices, even if this is not your first boat.

You can arrange an instructional trip with your trader.

Get familiar with the reaction of the boat due to course changes with small power. Pay attention to the propeller effect at running forward and reverse

2.7. Manoeuvring by engine

Pay attention to the recommendations in the engine operation manual.

- Switch on the main switch.
- Check whether the single-lever control is in neutral position.
- Begin the start procedure.
- In case the engine does not start, repeat the start procedure after a short pause.
- If the engine does not start after the third try, please check the reason.

After the successful start of the engine and all systems were checked, e.g. the cooling system, you can start the first trial. Pay attention to the direction of rotation of the propellers and manoeuvre carefully.

Practise the man-over-board manoeuvre and the anchoring regularly.

2.8. Checking the systems

On principle, the boat is delivered in working order, if not otherwise agreed upon. We attempt to convey the necessary knowledge and special features to you when delivering the boat.

Before you start the systems the first time, you should check all systems on board step by step. Use this safety manual and the operation manual of the boat. You will learn where the different devices and appliances are located and their operation.

Repeat this checks if you have do not used the boat over a longer time, especially before the new water sports season starts.

3. Environmental Protection

All our efforts were taken that the materials used to build this yacht will not harm the environment. There are a number of regulations regarding environmental protection, and we advise you to observe them when using your boat. The following section contains some notes with regard to the environment protection.

Sailing is a quiet sport. Please handle your boat in a responsible manner and render your contribution so that nature is not damaged more than inevitable.

Please pay attention these notes carefully.

3.1. Fuels and oil

Fuels and oil are an environmental hazard because a faulting over a longer time can result in restriction or damage of the environment.

Handle these substances carefully on board so that nothing goes overboard when refilling or pumping out.

Take special care before draining the boat that there is no oil in the bilge water. Use special oil sump agents to clean the bilge water or pump this mixture into a separate canister and deposit ashore.

3.2. Waste

Waste of all sorts must be disposed according to environmental regulations. For this purpose you should separate the waste on board and dispose of it ashore in the appropriate waste containers provided by the ports.

Reduce the amount of waste, in particular by reducing packaging! Use packaging that can be reduced in volume after use.

Glass packaging do not belong in the water either!

3.3. Sound

Sound is also ecological damaged. We have realized some soundproofing measures to reduce the sound, especially of the engines, below the legal permitted values. Maintain and preserve the engine room sound insulation. Do not paint over the insulation.

You should additionally choose engine speeds that keep noise within bearable limits.

3.4. Swell

Reduce speed when driving in narrow waters and in the vicinity of protected coastal zones.

Pay attention to relevant signs and speed restrictions.

3.5. Exhaust gases

Exhaust gases are unavoidable. We chose our engines according to the most favourable exhaust emission values. Pay attention to the colour of the exhaust gas as this can be an indication of a faulty adjustment of the engine. A blue or sooty appearance is a sign of serious adjustment errors. Have them repaired!

Do not run the engine as an "auxiliary aggregate" in the port for charging the batteries. Use the shore connection instead.

3.6. Antifouling, painting

There are a wide range of antifouling and protective paint products available on today's market for use in preventing marine fouling of the hull below the waterline. These products have varying properties and effects to be matched with the intended sailing use and water type. Care must be taken in checking the copper oxide content of the selected anti-fouling product. Products with high copper or copper oxide content could create a galvanic reaction with the aluminium alloy of your yacht's rudder stock or any other exposed underwater aluminium alloy part. Consult your dealer or a specialist marine coatings supplier for advice on final product selection.

But if the coating has to be grinded to some extent you should arrange these activities with the port officials. Generally the ground under the yacht has to be covered with some plastic clothes to collect the rubbed down dust and dispose it.

3.7. Varnish remover

Most varnish removers contain aggressive substances and should not be used or as little as possible. A mechanical removal of paint is the much better way. Don't use varnish or paint removers.

3.8. Black water

The toilet produces most of the black water on board. It is collected in a tank and should be disposed of on shore by sucking it out. When in a port, it makes sense to always use the port's facilities.

Please note that the Baltic Sea Convention, for example, prohibits the discharge of black water tanks. Some countries have adopted regulations prescribing that the board discharge openings be sealed.

3.9. Nature conservation

Please handle your boat in a responsible way. Avoid the restriction of the nature more than inevitable.

Pay attention to the information on conservation areas, national parks and other protected areas.

Especially in nature reserves which are allowed for navigation you should follow all regulations strictly.

Pay attention to the regulations of ocean pollution prevention.

4. Maintenance

Advice for the initial operation:

- Volvo pre delivery inspection by a Volvo Penta dealer
- Read the instructions supplied for each component
- Calibrate all electronic equipment following the manufacturers recommended procedure
- Inspect the security of all seacocks and hose clamps
- Check all systems

Advice for first inspection (after 50 hours of sailing):

- Inspect the condition of the sacrificial anode(s)
- Inspect all seacocks and check the security of all hose clamps
- Check the steering system (lock nuts, cable tension,...)
- Check for leaks above and below the waterline
- Check the halyards of chafe marks
- Have the running and standing rigging checked by a competent person.

Advice for regular maintenance:

- The points as listed for first inspection
- Clean the deck surface with fresh water, when cleaning teak deck areas take care to use a non-abrasive cloth. Should more aggressive cleaning be required then use a soft brush at 90 degrees to the direction of the wood grain.
- Washdown blocks and winches with fresh water
- Polish stainless steel fittings to maintain their corrosion-resistant properties
- Clean the sprayhood and maindrop with fresh water
- Clean the Rig / Furlex and sails with fresh water
- Check the mast foot and mast collar
- Descale the fresh water system
- Clean the steering system with fresh water
- Check the guardrail tension and condition
- Clean the seals of hatches and windows and treat with suitable maintenance agent
- Check electrical contacts and connections
- Maintain systems and devices by following the manufacturer supplied documentation

The list of recommendations above does not purport to be complete. It is intended as an overview. For more information see the individual chapters.



The owner is solely responsible for the maintenance and upkeep of the yacht and for ensuring that this work is carried out by suitably experienced and qualified persons.

Maintenance must be carried out according to the manufacturers recommendations, those of the individual equipment suppliers and good working practice.

Failure to follow the guidelines will result in poor reliability, premature failure and may void warranty coverage.

4.1. External inspection

Winter storage is the right opportunity to thoroughly inspect the hull and all supporting parts. A damaged coating or visible parts of the laminate or the wood must be repaired, in compliance with the coating's manufacturer's recommendations. The yard or your dealer is able to supply the coating, resin and reinforcement material.

Further information to the technical equipment of the yacht can be found in this manual or in the operating manuals of the respective appliances and systems.

4.2. Maintenance and cleaning

The boat should only be cleaned with fresh water if possible. Environmentally compatible cleaning agents suitable for FRP and varnished surfaces may be used for persistent dirt. Do not use any agents containing silicone.

Special agents are offered for further treatment like refurbishing and sealing FRP surfaces. Only use suitable agents for this!

Teak

Through the effects of weather, teak wood receives a natural gray colour. This colour does not affect the physical properties of the wood. The robust weather resistant properties of teak make the application of weather protective coatings unnecessary.

We recommend the use of fresh water, or fresh water with a minimal amount of a neutral detergent, and a soft brush for cleaning teak. For hard stains or extremely dirty decks use a hard sponge.

An important note is to make sure and brush across the grain of the wood. If you brush in the direction of the wood grain, you run the risk of leaving small ruts in the wood. You will if fact brush the softer wood out and leave the harder wood in place. The use of a pressure washer on the teak is not recommended. This could damage the wood as well as the seams between the wood.

Metallic parts

Please note: Stainless steels are a group of low-maintenance, corrosion resistant steels that contain a minimum of 10.5% Chromium. At this point the Chromium forms a tenacious, stable oxide film called the passive film. This passive film forms instantaneously in ordinary atmospheres and has the remarkable capability of being self-healing should the surface of the material become damaged.

All grades of stainless steels may, over time, show signs of corrosion in the form of rust or staining, due to dirt deposits collecting in the surface pores of the material.

The dirt deposits actively prevent the Chromium from oxidizing, resulting in the protective passive film being unable to form in that area and allowing under deposit corrosion to take place.

To achieve the maximum corrosion resistance, therefore, the surface of the stainless must be kept clean as part of a routine maintenance plan.

The frequency of cleaning is dependent on the application - a simple rule is: Clean the metal when it is dirty. This may vary from one to four times a year.

Metallic parts may only be cleaned with metal polish. Please note that aluminium parts are anodised and must not be treated with scratching or polishing agents.

Washdown the windlass and anchor chain regularly with fresh water.

If the boat is not in use for a long period of time stand the cushions upright. Air the cushions regularly in the sun.

Defrost the fridge / freezer regularly. If the boat is not in use for a long period of time, open the doors of the refrigerator / freezer to prevent mold growth.

4.3. Rigging and sails

4.3.1. Rigging

For safely working up the mast, please follow the following safety guidelines:

In the Harbour

Please follow the following safety guidelines: The halyard line should not be clipped into the Boson's chair with a shackle, it should be tied in with a knot. (Background: is that it is easier to see material defects in the rope)

As a safety precaution a second halyard or line must be used. This can be attached to the same D-ring on the seat, however the risk that material fatigue on the boson's chair and possible ripping out of the D-ring is greater. Recommended is a second independent webbing harness be used where the second halyard or line can be attached. It is very important to note that a additional chest strap or line be attached to the halyard. An additional line attachment at chest level will prevent the person from falling/flipping backwards out of the chair.

The person in the Boson's chair should always hold on to the mast, the stays, or the shrouds.

At Sea

The safety precautions are the same as in the harbour, with the following added precautions. To avoid a person swinging in the Boson's chair when grip or hold is lost, secure an extra line to the chair/webbing that leads down to a secure point on the mast foot with a block. This line can then be fed from below, once the correct work height has been reach the line can be secured. This procedure will not eliminate swinging, but can greatly reduce it especially when working very high on the mast. This extra line down to the deck can also help stabilize someone being lowered that can no longer hold themselves tight. An extra safety line directly fastened to the mast is sometimes necessary. However if the person up the mast is knocked unconscious this will hinder the lowering of that person. These risk should be properly assessed before ascending the mast.

Stainless steel fittings that are tarnished or have a rust film should be polished to maintain their good properties.

Clean the furlex regularly with fresh water and lubricate the bearing with waterproof furlex grease.



Note

If the boat is not in use take the strain off the jib / genoa halyard.

4.3.2. Sails

It is important to avoid luffing, fluttering or flogging, in order to conserve the strength and shape of the sails.

Wear is a further problem. The first priority is to avoid any kind of chafing wherever possible. Where chafe is unavoidable it must be limited as much as possible. Check your boat thoroughly for unprotected pins, sharp ends of fittings, exposed screw heads, etc...

Where contact is expected, for example where the sail may push against the spreaders, it is important that measures are taken to protect the appropriate areas of the sail with self adhesive protection material (spreader patches). Spreader tips and stanchion tops must be protected with plastic or leather guards or tape.

Sails are sensitive to UV light and should always be covered, when not in use.

If the sails are not needed they should be kept dry, salt free and loosely folded in their sail bags. Avoid repeated flaking of the sails always in the same folds. Most sails live longer when they are rolled up and stored in long bag.

4.4. Painting

The underwater-part of your yacht can be protected by a paint system of several coats. The last coat is the antifouling which needs to be inspected and re-coated in regular intervals. If possible, do not alter the painting system if the compatibility of the systems is unknown.

Dispose of the abrasive dust according to the manufacturer's instructions.

The varnish inside the boat only needs to be reworked or renewed if damaged. If you have any questions concerning the coatings, contact the dealer or the yard.

4.5. Wear and spare parts

Should the boat be damaged, only use original parts or components of the same quality if possible. This applies mainly to parts which have to stand certain stresses, e.g. parts of the rigging, deck equipment etc.

Your dealer can help you in this respect.

4.6. Repairs

Repairs on the hull, drive systems, rigging and sails should be performed by a specialist company, because they have the required technical equipment and special knowledge of how to return to you a high quality boat after a repair. This applies to damages of the structure, in particular.

Your dealer will support you and can name specialist companies able to perform expertly repairs.

4.7. Inspection of units and systems

The reliable functioning of the individual systems is important for safe operation the boat. Check equipment and systems regularly for their operational readiness. For this purpose, use the manual and/or the enclosed operating instructions.

All through hull systems below the waterline are secured with double hose clamps. Check them regularly for a tight fit.

The steering system is of a high material standard and requires little maintenance. Clean the steering system regularly with fresh water and polish the steering pedestal with car wax at least twice a year. Periodically check the mounting of the bolts, nuts, drag links and the tension of wire or chain.

For tighten the wire use the nut on the wire near the gearbox. Tighten the wire terminals on the gearbox till you can push the wire 1 -2 cm with 5kg pressure.

The chain should at all times be properly greased on the complete length of the chain. Dismount the brake spinner and the wheel from the steerer shaft. Now unscrew 6pcs screws to dismount the bulkhead steerer to get to the chain and the sprocket on the shaft.

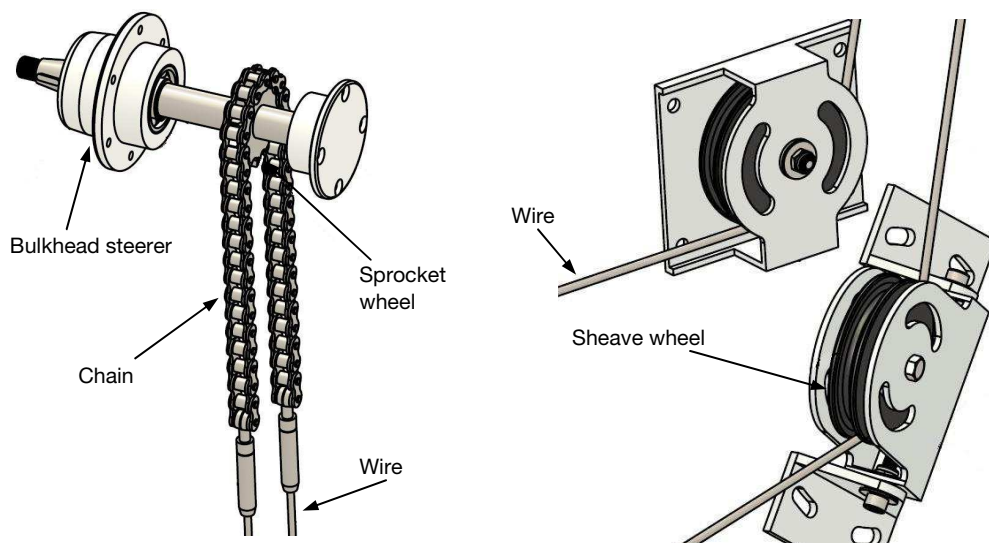

Check that the sheaves are properly mounted and that the sheave wheel isn't worn down or loose in the sheave housing. Check that the wire isn't fractured or worn down. The sheave and the wire does not grease at any time.

Check the rudder stock for signs of electrolysis annually. This can be seen by circular corrosion on the shaft.

Another point is the connection between the rudder shaft and quadrant. Check carefully that there is no clearance between the parts. Check the vertical locking of the rudder annually.

The bottom bearing doesn't need any maintenance except for a good hose down when the ship is taken out of the water. The main reason for this hose down is to remove the salt water out of the bearing housing so it can't crystallize.

If the shaft rotates irregularly, it could be that some rollers have developed a flat side. This will have been caused by a temporarily blocking of the rollers by dirt parts. In most cases this will have been caused by dirt falling in from above on open tube systems. Please use a gaiter to prevent this in future. The exchange of the rollers is quite simple: the internal part of the bearing, the so called ball with rollers can easily be removed by rotating it 90° and pulling it out of the groove. A light film of grease should be between the ball and housing.



Note

No grease is allowed inside the bearing, between the rollers.

The top bearing doesn't need any maintenance. It should yearly hose it down to wash away any sand and dust between the rollers and the housing.

Appropriate measures must be taken to prevent damages to the fuel conduits.



Attention

Prevent inflammable materials or liquids from coming in contact with hot parts of the engine!



Attention

Equipment that contains petrol may not be stored in areas that are not meant for it!

4.8. Winter storage

Winter storage is the time during which your boat is left unattended for a longer time. During this period it must stand securely and should be stored in a place protecting it from atmospheric effects.

Please read section **Fehler! Verweisquelle konnte nicht gefunden werden. Fehler! Verweisquelle konnte nicht gefunden werden..**

Dispose of all waste.

Remove all sophisticated equipment from the boat. Cushions should be stored in dry, ventilated and frost-free places.

If the boat is covered by a tarpaulin, you should ensure that the air can circulate well underneath it. If possible, keep the ventilation apertures of the boat open.

The tarpaulin should be well fixed so that no abrasions can take place especially the hull.

4.8.1. Hull and deck

Clean the yacht immediately after hauling. High-pressure-cleaner can remove all fouling.

For boats sailing in seawater: remove all rests of salt, because it can speed up the corrosion.

The boat should only be cleaned with fresh water if possible. Environmentally compatible cleaning agents suitable for FRP and varnished surfaces may be used for persistent dirt.

Special agents are offered for further treatment such as refurbishing and sealing varnished surfaces. Only use agents suitable for this!

Metallic parts may only be cleaned with metal polish. Please note that aluminium parts are anodised and must not be treated with scratching or polishing agents.

4.8.2. Rigging

Prior to winter storage, rinse the entire rigging and the sails with ample fresh water. The sails should not be dried in the wind in the mast (the flapping wear the sail and seams and there is a risk that cracks appear in the rigging). In the winter storage the rigging should undergo a thorough visual inspection. This includes, in particular, the running rigging, but also the halyard block, the mast and boom extrusion as well as their bearings. Minor damages can be repaired with little effort when the rigging is down.

Seams and thimbles should be thoroughly inspected. They shall be repaired if necessary.

The sails should be entrusted an expert for maintenance and repair.

4.8.3. Electrical equipment

Contacts must be free of corrosion and securely connected. Check the connections once a year.

The batteries should be taken from board and stored, well charged, in a dry and frost-free place. If they remain on board, they should be recharged regularly around once a month.

4.8.4. Systems and tanks

Also rinse the black water conduits well. Empty the freshwater and black water tanks, electric boiler and all conduits belonging to them. Open all the conduits and clean the connections properly. Cover the open tanks, conduits and hoses at the ends with gauze or cloth (air: YES, dust: NO).

Let the seacocks open in winter storage because they may burst open in heavy frost.

It is better to fill the diesel tank to reduce condensation. Check whether the conduits are firmly seated.

At the engine, the seawater circuit including the exhaust system are to be emptied of water. If the internal cooling water circuit contains an antifreeze agent for expected low temperatures, the inner circulation needn't be drained.

5. Live saving appliances

In principle, the boat is **not** equipped with live saving appliances. The owner or operator is responsible to provide the yacht with sufficient life jackets and inflatable life rafts, in compliance with the maximum number of persons (12). They shall be good accessible and ready for use.

The container with the life rafts can be attached in cockpit box in front of the companion way.



Attention

If you use self-inflatable life rafts or life jackets, keep to the inspection intervals.

Life jackets can be stored in the cockpit's locker seats. If necessary, further live saving appliances should be stored aboard.

6. Warranty

Please contact your contracting partner in case of a warranty claim.

7. Concluding remarks and notes

In the preceding sections we have tried to give you some advice on how to handle the boat.

You have certainly gained experience with boats yourself. Our advice can only be supplementary and does not replace your own personal seamanlike diligence as owner or skipper.

As shipyard, we have delivered you a product that, according to the best available technology and in compliance with the European Recreational Craft Directive, is a safe and reliable sailing yacht satisfying the demands arising from its use.

Extreme strains stemming from touching the sea bed, collisions etc. can, of course, damage the boat.

The owner or skipper is responsible for personal safety equipment and for providing all persons on board with personal life jackets. This also includes the acquisition and maintenance of a life raft, distress signals, first-aid box, tools, important spare parts, etc.

Since the European Recreational Craft Directive pays special attention to safety and fire protection, you should familiarise your crew with the safety installations and fire extinguishers and how to handle them.

We are constantly working on the further development of our sailing yachts. Please understand that shape, equipment and technology are subject to change. For this reason, no claims can be made from any information, figures or descriptions in this manual.

Should your sailing yacht be provided with equipment details not described in this manual or if no description is included in the owner's manual and operating instructions, your contracting party will inform you of the correct operation and care.

8. List of delivered manuals, plans and operating instructions

See delivery notes

Proof of Identity

(to be filled out by the dealer or contracting party)

- 1. First launch:
- 2. Date (delivery to the owner):
- 3. Boat type: Hanse 575
- 4. Hull and/or Identification No.: DE-HANT0042G314
- 5. Contract number:
- 6. Name of the yacht:
- 7. Engine (manufacturer and type):
- 8. Engine serial number:
- 9. Gearing (manufacturer, type, ratio):
- 10. Propeller (manufacturer, type, dims):
- 11. Dealer, representative (name, address):
- 12.
- 13.
- 14. Signature/stamp of dealer:

All readings in this skipper's manual base upon information of the shipyard and it's diagrams. The author assumes no liability for false specifications or changes in systems and equipments.



Personal data (1st owner)

DE-HANT0042G314

Model

Hanse 575

Deep

Property

Single owner

Partnership

Mr.

Mrs.

Firm

Title

.....

1st name:

.....

Family name:

.....

Firm

.....

Address details:

Street

.....
.....

Number

.....

Postcode

.....

Town

.....

County

.....

Country

.....

Communication:

Phone

.....

Phone (e. g. mobile phone)

.....

Fax

.....

Email 1

.....

Email 2

.....

Website

.....



Personal data (2nd owner)

DE-HANT0042G314

Model

Hanse 575

Deep

Property

Single owner

Partnership

Mr.

Mrs.

Firm

Title

.....

1st name:

.....

Family name:

.....

Firm

.....

Address details:

Street

.....

.....

Number

.....

Postcode

.....

Town

.....

County

.....

Country

.....

Communication:

Phone

.....

Phone (e. g. mobile phone)

.....

Fax

.....

Email 1

.....

Email 2

.....

Website

.....



Personal data (3rd owner)

DE-HANT0042G314

Model

Hanse 575

Deep

Property

Single owner

Partnership

Mr.

Mrs.

Firm

Title

.....

1st name:

.....

Family name:

.....

Firm

.....

Address details:

Street

.....

.....

Number

.....

Postcode

.....

Town

.....

County

.....

Country

.....

Communication:

Phone

.....

Phone (e. g. mobile phone)

.....

Fax

.....

Email 1

.....

Email 2

.....

Website

.....



Please sign and send back to:

Dealer's address:

[Empty rectangular box for dealer's address]

Acknowledgement of Receipt

Name:

Address:

.....

Owner of the sailing yacht **"Hanse 575"** with the CIN **DE-HANT0042G314**

This warranty commences on.....(date)

Signature:.....

Information for the dealer:

Please send this acknowledgement of receipt

to:

HanseYachts AG
After Sales Department
Salinenstrasse 22

D-17489 Greifswald, Germany

